

**KOBELCO**

HYDRAULIC CRAWLER CRANE

**7055**

Model: 7055-3F

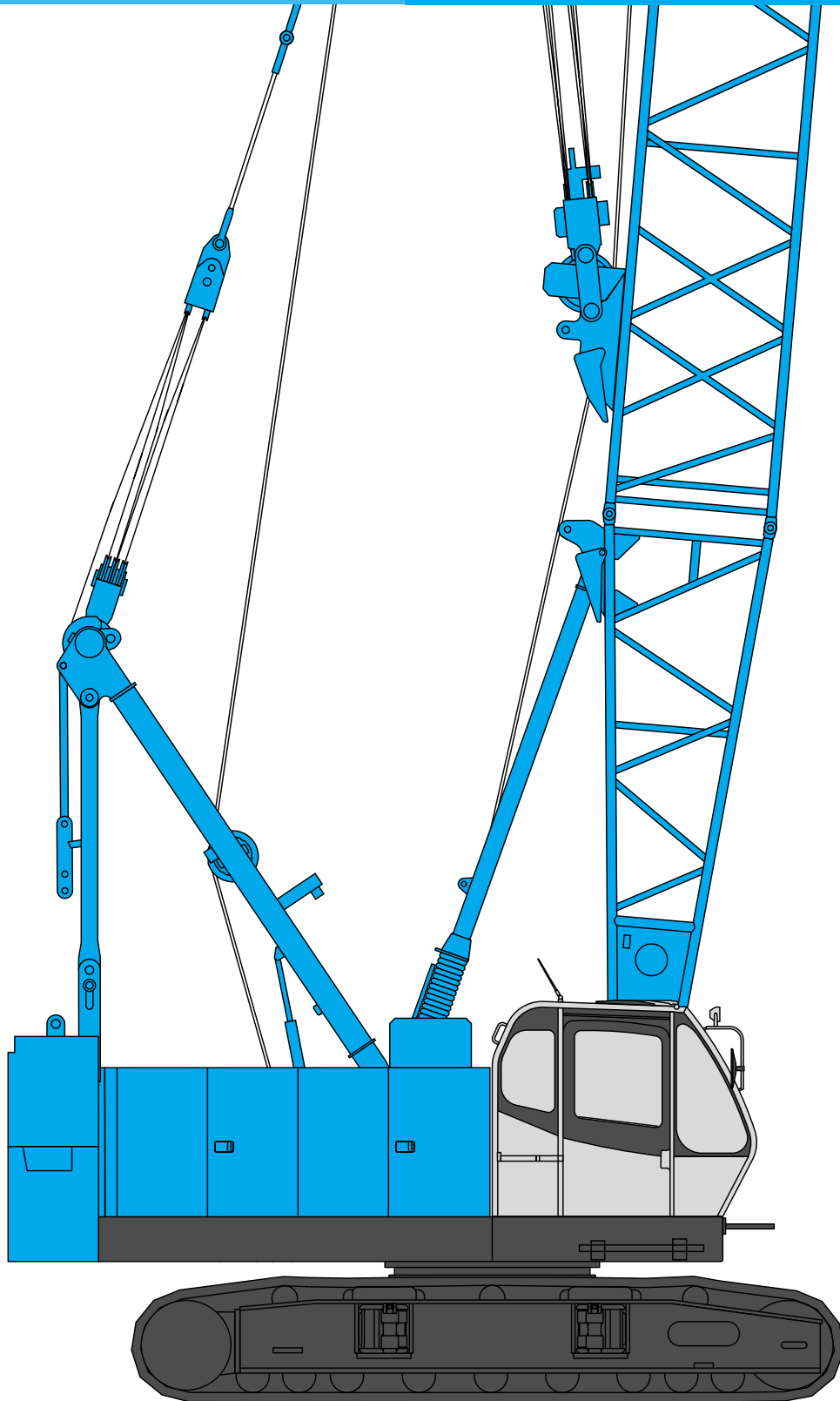

**Max. Lifting Capacity: 55 t x 3.7 m**

**Max. Crane Boom Length: 51.8 m**

**Max. Fixed Jib Combination: 42.7 + 12.2 m, 39.6 + 18.3 m**

**Max. Tower Jib Combination: 42.4 + 29.0 m**

# CONFIGURATION

## Crane Boom

Max. Lifting Capacity:  
55 metric ton x 3.7 m  
Max. Boom Length:  
51.8 m

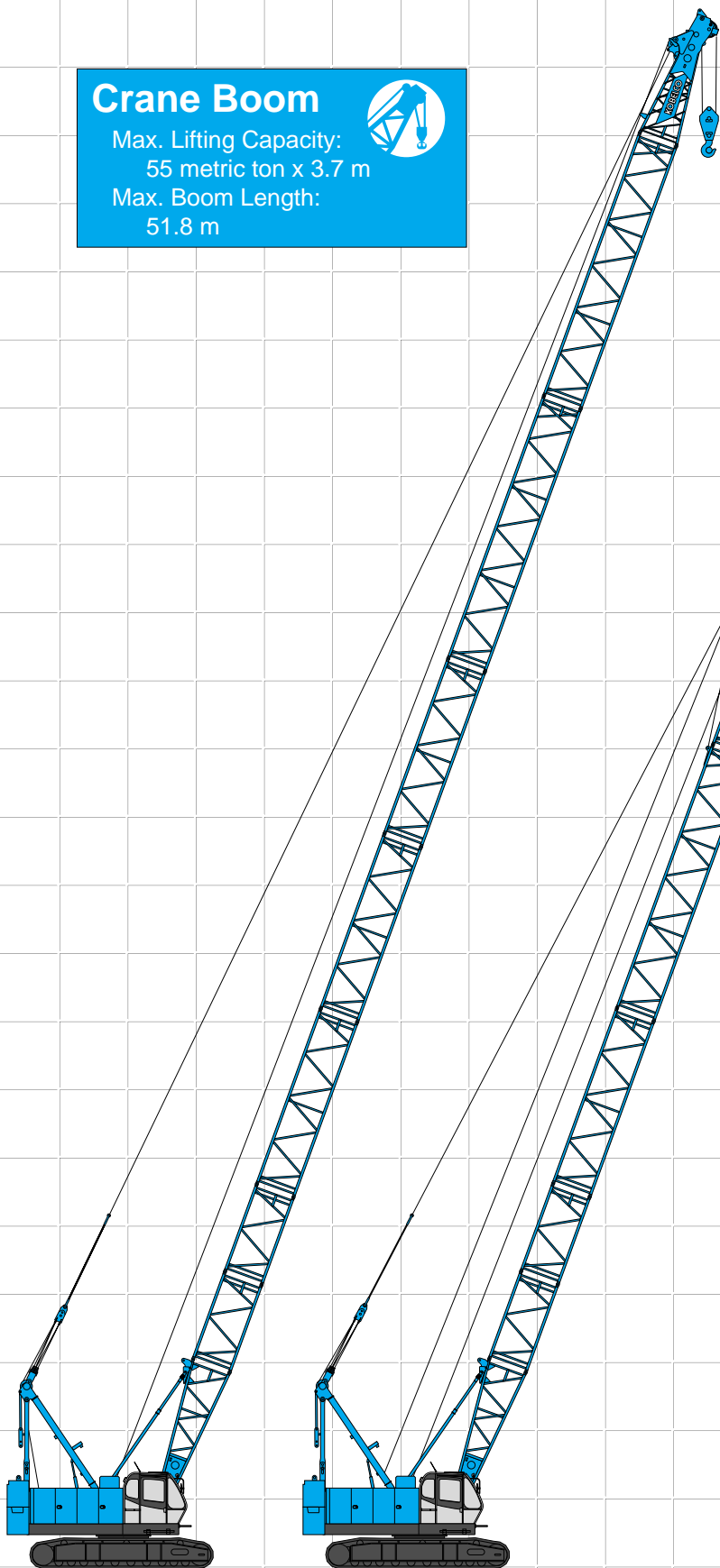

## Fixed Jib

Max. Lifting Capacity:  
7 metric ton x 16.0 m  
Max. Combination:  
42.7 m + 12.2 m, 39.6 m + 18.3 m

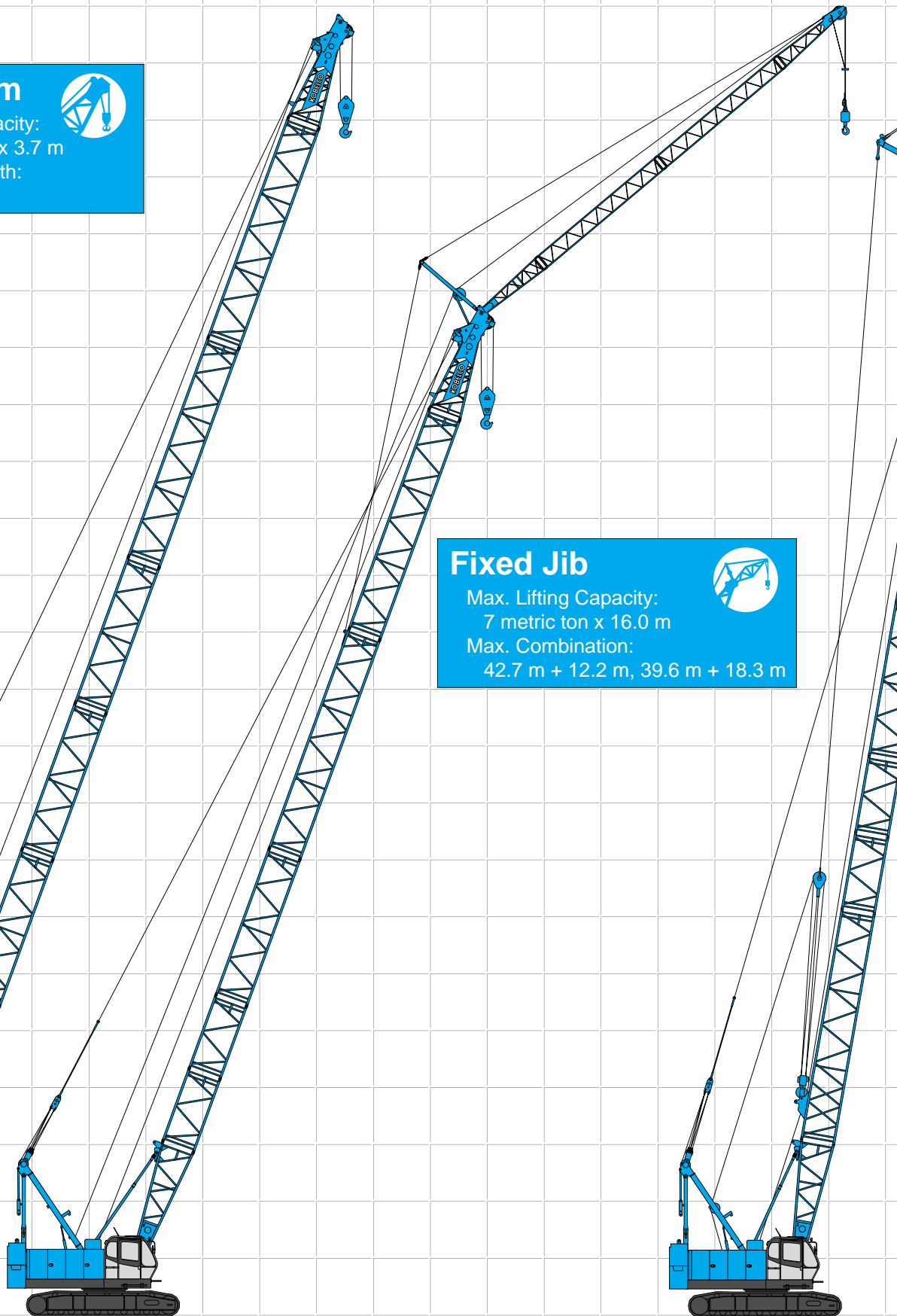

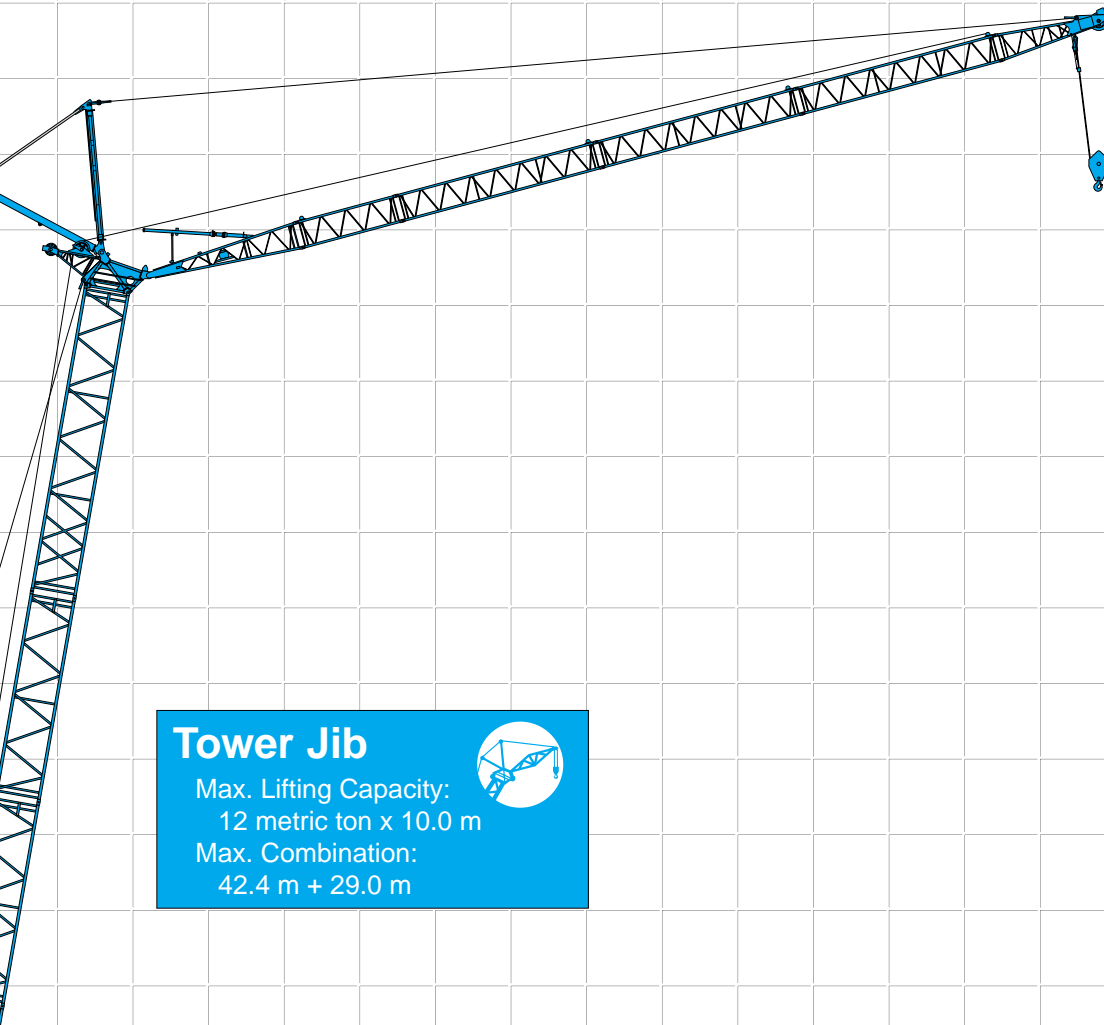

## Tower Jib

Max. Lifting Capacity:  
12 metric ton x 10.0 m  
Max. Combination:  
42.4 m + 29.0 m



## CONTENTS

Configuration .....	1
Specifications .....	3
General Dimensions .....	5
<b>Boom and Jib Arrangements</b>	
Crane Boom Arrangements .....	7
Fixed Jib Arrangements .....	7
Tower Arrangements .....	8
Tower Jib Arrangements .....	8
<b>Working Ranges and Lifting Capacities</b>	
Crane Boom Working Ranges .....	10
Crane Boom Lifting Capacity .....	11
Auxiliary Sheave Lifting Capacity for Crane Boom .....	11
Fixed Jib Working Ranges .....	12
Fixed Jib Lifting Capacities .....	13
Tower Jib Working Ranges .....	15
Tower Jib Lifting Capacities .....	17
Parts and Attachments ...	21

# SPECIFICATIONS



## Power Plant

**Model:** Hino diesel engine J08E-TM

**Type:** Water-cooled, direct fuel injection, with turbocharger  
Complies with NRMM (Europe) Stage IIIA and US EPA Tier III.

**Displacement:** 7.684 liters

**Rated Power:** 159 kW at 2,000 min<sup>-1</sup> {rpm} (ISO)

**Max. torque:** 797 N·m/1,600 min<sup>-1</sup>

**Cooling system:** Liquid, recirculating bypass

**Starter:** 24 V/5.0 kW

**Radiator:** Corrugated type core, thermostatically controlled

**Air cleaner:** Dry type with replaceable paper element

**Throttle:** Electric throttle control, twist grip type

**Fuel filter:** Replaceable paper element

**Batteries:** Two 12 V, 136Ah/5HR capacity batteries, series connected.

**Fuel tank capacity:** 400 liters



## Hydraulic System

Three variable displacement piston pumps are driven by heavy-duty pump drive. Two of variable displacement pumps are used in the main hook hoist circuit, boom hoist circuit, auxiliary hook hoist circuit, third hoist circuit and each propel circuit. The other is used in the swing circuit.

**Control:** Full-flow hydraulic control system for infinitely variable pressure to front and rear drums, boom hoist brakes and clutches. Controls respond instantly to the touch, delivering smooth function operation.

**Cooling:** Oil-to-air heat exchanger (plate-fin type)

**Filtration:** Full-flow and bypass type with replaceable element

**Electrical system:** All wiring corded for easy servicing, individual fused branch circuits.

**Max. relief valve pressure:**

**Load hoist, boom hoist and propel system:**

31.9 MPa {325 kgf/cm<sup>2</sup>}

**Swing system:** 27.5 MPa {280 kgf/cm<sup>2</sup>}

**Control system:** 7.0 MPa {71 kgf/cm<sup>2</sup>}

**Reservoir capacity:** 440 liters



## Boom Hoisting System

Powered by a hydraulic motor through a planetary reducer.

**Brake:** A spring-set, hydraulically released multiple-disc brake is mounted on the boom hoist motor and operated through a counter-balance valve.

**Drum lock:** External ratchet for locking drum.

**Drum:** Single drum, grooved for 16 mm dia. wire rope.

**Line speed:** Single line on first drum layer

**Hoisting/Lowering:** 70 to 2 m/min

**Diameter of wire ropes**

**Boom guy line:** 30 mm

**Boom hoist reeving:** 12 parts of 16 mm dia. high strength wire rope

**Boom backstops:** Telescopic type with spring bumper  
Required for all boom lengths



## Load Hoist System

Front and rear drums for load hoist powered by a hydraulic variable plunger motors, driven through planetary reducers.

**Brake:** A spring-set, hydraulically released multiple-disc brake is mounted on the hoist motor and operated through a counter-balance valve. Both positive and negative brake systems are available.

**Drum lock:** External ratchet for locking drum.

**Drums:**

**Front drum:**

550 mm P.C.D. x 545 mm Lg. wide drum, grooved for 22 mm wire rope. Rope capacity is 175 m working length and 335 m storage length.

**Rear drum:**

550 mm P.C.D. x 545 mm Lg. wide drum, grooved for 22 mm wire rope. Rope capacity is 125 m working length and 335 m storage length.

Note: Rope lengths listed above denote drum capacity and may differ from actual rope lengths supplied when machinery is shipped.

**Line speed:** Single line on the first drum layer

**Hoisting/Lowering:** 120 to 3 m/min

**Tower Jib Hoisting/Lowering:** 90 to 3 m/min (Rear drum)

**Line Pull:**

**Rated line pull (Single-line):** 68.6 kN {7.0 tf}



## Swing System

Swing unit is powered by hydraulic motor driving spur gear through planetary reducer, the swing system provides 360° rotation.

**Swing parking brakes:** A spring-set, hydraulically released multiple-disc brake is mounted on swing motor.

**Swing circle:** Single-row ball bearing with an integral internally cut swing gear.

**Swing lock:** Manually, two position lock for transportation

**Swing speed:** 4.0 min<sup>-1</sup> {rpm}



## Upper Structure

Torsion-free precision machined upper frame. All components are located clearly and service friendly. Engine with low noise level.

**Counterweight:** 15.2 ton

**Additional counterweight:** 3.3 ton

Note: Additional counterweight is required when raising or lowering the tower length of 42.4 m.



## Cab & Control

Totally enclosed, full vision cab with safety glass, fully adjustable, high backed seat with a head-rest and armrests, and intermittent wiper and window washer (skylight and front window).

### Cab fittings:

Air conditioner, convenient compartment (for tool), cup holder, ashtray, cigarette lighter, sun visor, roof blind, tinted glass, floor mat, foot-rest, shoe tray

### Controls:

Four adjustable levers for front drum, rear drum, boom drum and swing controls



## Lower Structure

Steel-welded carbody with axles. Crawler assemblies can be hydraulically extended for wide-track operation or retracted for transportation. Crawler belt tension is maintained by hydraulic jack force on the track-adjusting bearing block.

**Crawler drive:** Independent hydraulic propel drive is built into each crawler side frame. Each drive consists of a hydraulic motor propelling a driving tumbler through a planetary gear box. Hydraulic motor and gear box are built into the crawler side frame within the shoe width.

**Crawler brakes:** Spring-set, hydraulically released parking brakes are built into each propel drive.

**Steering mechanism:** A hydraulic propel system provides both skid steering (driving one track only) and counter-rotating steering (driving each track in opposite directions).

**Track rollers:** Sealed track rollers for maintenance-free operation.

**Shoes (flat):** 59 shoes, 760 mm wide each crawler

**Max. travel speed:** 2.4/1.5 km/h

**Max. gradeability:** 40%



## Weight

Including upper and lower machine, 15.2 ton counterweight, basic boom (or basic tower + basic tower jib), hook, and other accessories.

Specification	Weight	Ground pressure
Crane boom	Approx. 56.7 ton,	72.3 kPa {0.74 kgf/cm <sup>2</sup> }
Tower jib	Approx. 60.6 ton,	77.3 kPa {0.79 kgf/cm <sup>2</sup> }



## Attachment

### Boom and Jib:

Welded lattice construction using tubular, high-tensile steel chords with pin connections between sections.

### Boom and Jib Length

	Min. Length (Min. Combination)	Max. Length (Max. Combination)
Crane Boom	9.1 m	51.8 m
Fixed Jib	30.5 m + 6.1 m	42.7 m + 12.2 m 39.6 m + 18.3 m
Tower Jib	21.0 m + 16.8 m	42.4 m + 29.0 m

## Main Specifications (Model: 7055-3F)

Crane Boom	
Max. Lifting Capacity	55 t/3.7 m
Max. Length	51.8 m
Fixed Jib	
Max. Lifting Capacity	7 t/16.0 m
Max. Combination	42.7 m + 12.2 m, 39.6 m + 18.3 m
Tower Jib	
Max. Lifting Capacity	12 t/10.0 m
Max. Combination	42.4 m + 29.0 m
Tower Angle	60° ~ 90°
Main & Aux. Winch	
Max. Line Speed	120 m/min (1st layer)
Rated Line Pull (Single Line)	68.6 kN {7.0 tf}
Wire Rope Diameter	22 mm
Wire Rope Length	Crane 175 m (Main) 125 m (Aux.) Tower 220 m (Main) 120 m (Aux.)
Brake Type	Spring-set hydraulically released
Working Speed	
Swing Speed	4.0 min <sup>-1</sup> {rpm}
Travel Speed	2.4/1.5 km/h

Power Plant	
Model	Hino J08E-TM
Engine Output	159 kW/2,000 min <sup>-1</sup> {rpm}
Fuel Tank Capacity	400 liters
Hydraulic System	
Main Pumps	3 variable displacement
Max. Pressure	31.9 MPa {325 kgf/cm <sup>2</sup> }
Hydraulic Tank Capacity	440 liters
Weight	
Operating Weight*	Approx. 56.7 t
Ground Pressure*	72.3 kPa {0.74 kgf/cm <sup>2</sup> }
Counterweight	15.2 t
Transport Weight**	40.2 t

\* Including upper and lower machine, 15.2 ton counterweight, basic boom, hook, and other accessories.

\*\* Base machine with boom base, crawlers, gantry, lower spreader, upper spreader, wire ropes for main and boom hoist winches.

Units are SI units. {} indicates conventional units.

# GENERAL DIMENSIONS

## Crane Boom

(Unit: mm)

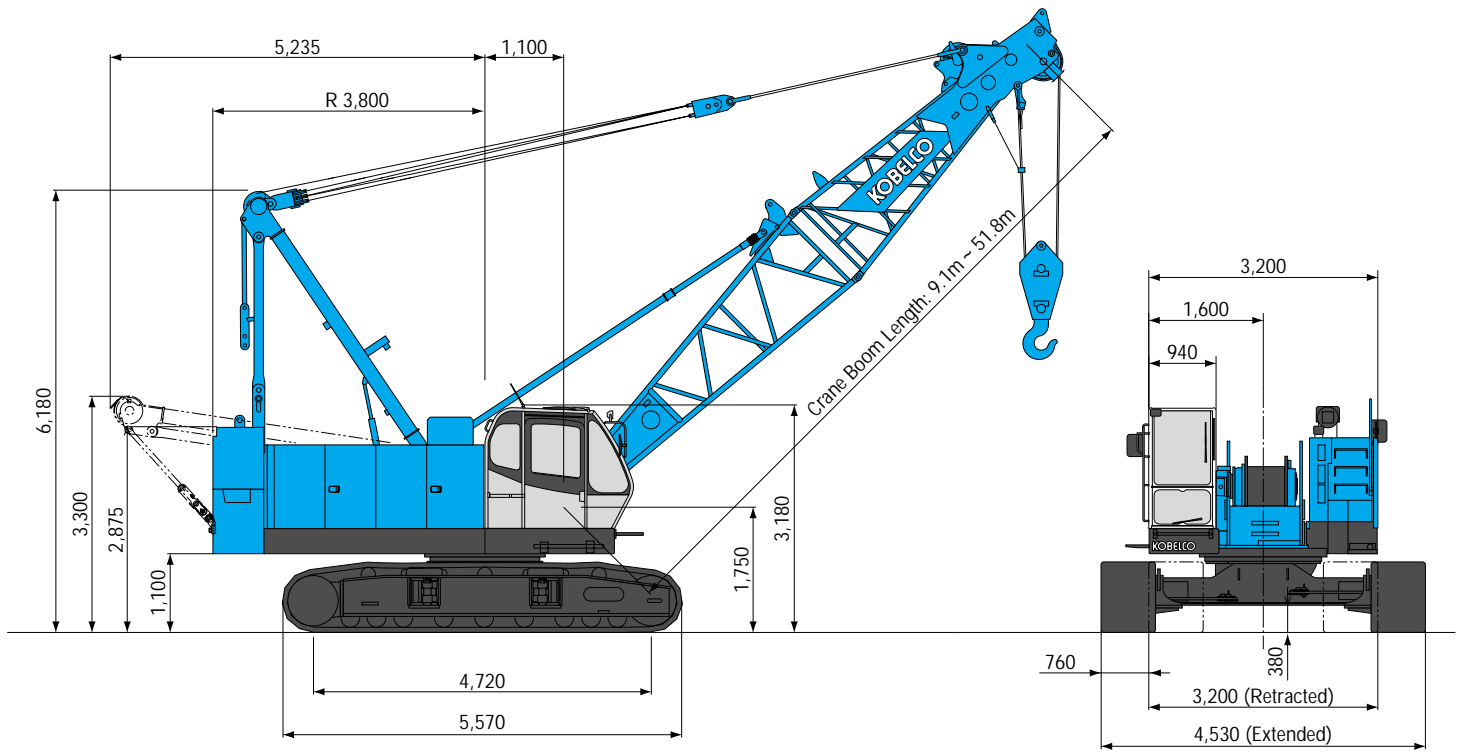

## Limit of Hook Lifting

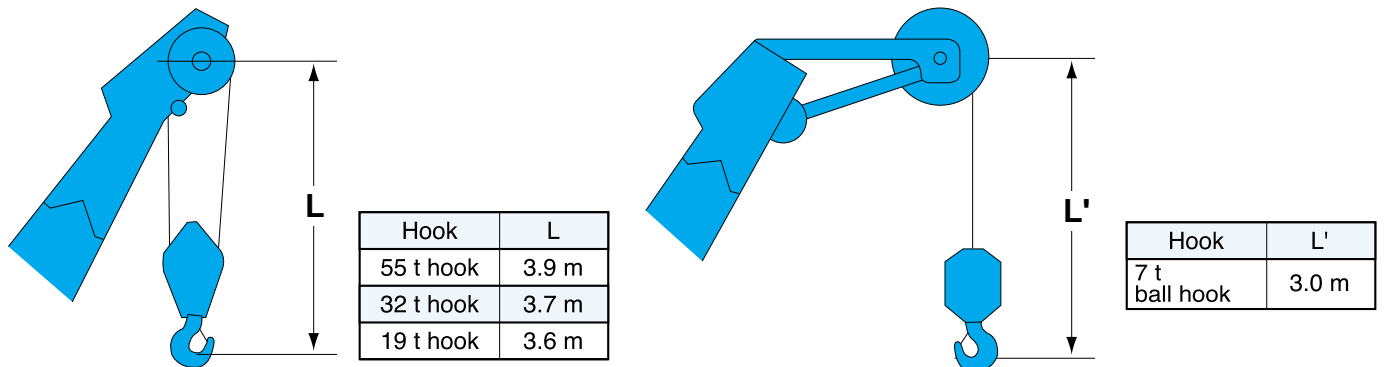

## Tower Jib

(Unit: mm)

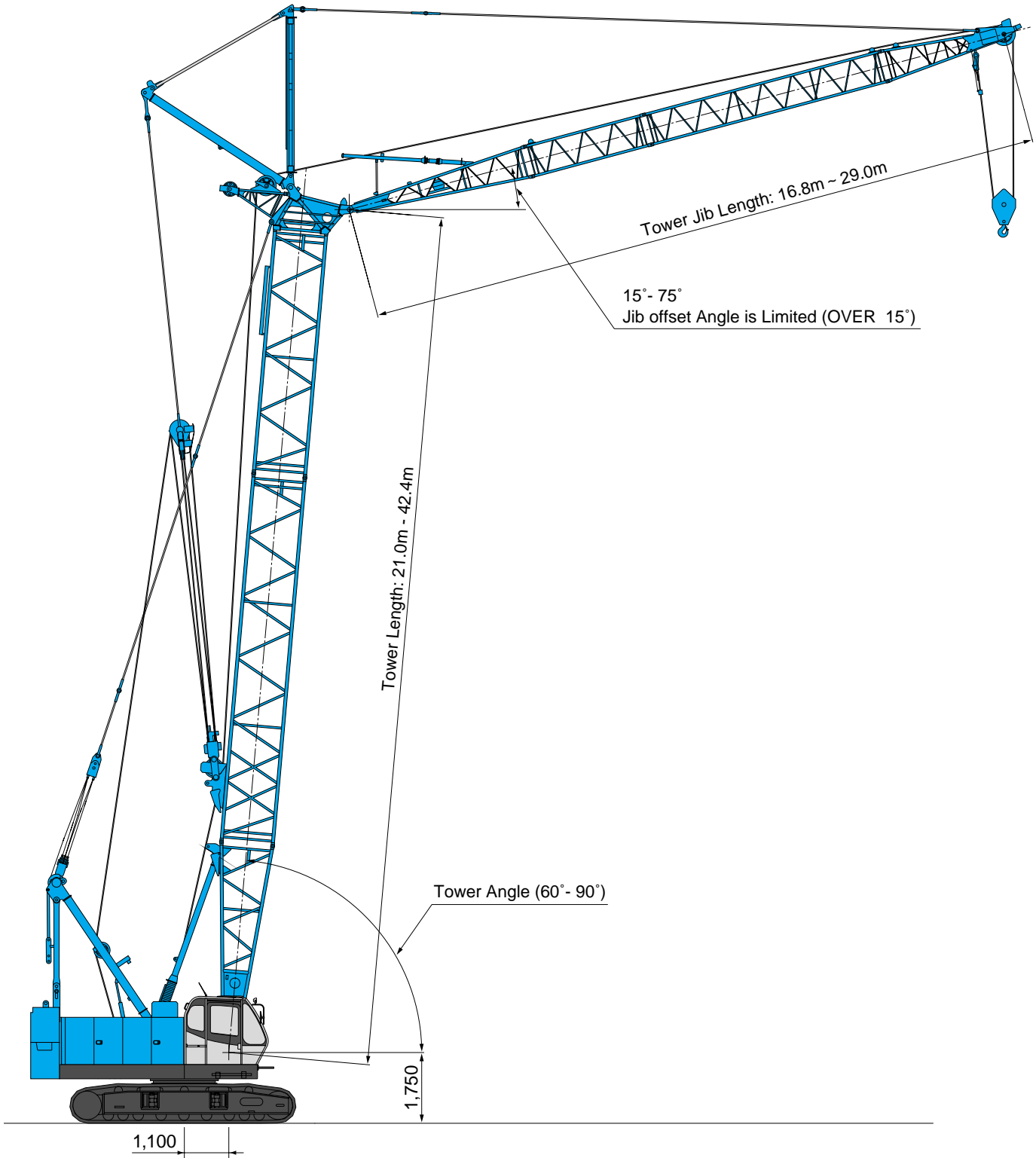

# BOOM AND JIB ARRANGEMENTS

## Crane Boom Arrangements

Boom length m (ft)	Boom arrangement
9.1 (30)	
12.2 (40)	※
15.2 (50)	※
18.3 (60)	※
21.3 (70)	※
24.4 (80)	※
27.4 (90)	※
30.5 (100)	※

Boom length m (ft)	Boom arrangement
33.5 (110)	※
36.6 (120)	※
39.6 (130)	※
42.7 (140)	※
45.7 (150)	※
48.8 (160)	※
51.8 (170)	※

Symbol	Boom Length	Remarks
	5.2 m	Boom Base
	3.9 m	Boom Top
	3.0 m	Insert Boom
	6.1 m	Insert Boom
	6.1 m	Insert Boom with Lug
	9.1 m	Insert Boom
	9.1 m	Insert Boom with Lug

↗ mark shows the guy line installing position when the fixed jib is used.

※ mark shows the standard boom arrangement which enables each boom length of less than that boom length to be configured.

Note: In the following cases a 6.1 m or 9.1 m insert boom with lug is required:

1. With a fixed jib fitted
2. When assembling a boom length of 39.6 m or over without using an auxiliary crane

## Fixed Jib Arrangements

Jib Guy Line:  $\phi$ 20 mm

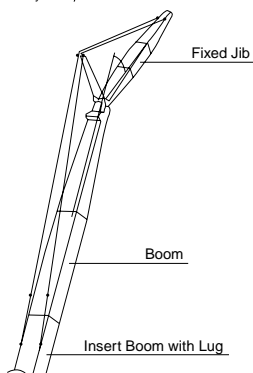

Crane boom length	Jib length m (ft)	Jib arrangement
30.5 m	6.1 (20)	
42.7 m	12.2 (40)	
30.5 m 39.6 m	18.3 (60)	

Symbol	Jib Length	Remarks
	3.0 m	Jib Base
	3.0 m	Jib Top
	6.1 m	Insert Jib



## Tower Arrangements

Tower length m (ft)	Tower arrangement
21.0 (69)	
24.1 (79)	※
27.1 (89)	※ 
30.2 (99)	※ 
33.2 (109)	※ 
36.3 (119)	※ 
39.3 (129)	※
42.4 (139)	※

Symbol	Tower Length	Remarks
	5.2 m	Boom Base
	0.6 m	Tower Cap
	3.0 m	Insert Boom
	6.1 m	Insert Boom
	9.1 m	Insert Boom
	9.1 m	Special Insert Boom for Tower

※ mark shows the standard tower arrangement which enables each tower length of less than that tower length to be configured.

## Tower Jib Arrangements

Jib length m (ft)	Jib arrangement
16.8 (55)	
19.8 (65)	※ 
22.9 (75)	※
25.9 (85)	※ 
29.0 (95)	※

Symbol	Tower Jib Length	Remarks
	4.6 m	Tower Jib Base
	3.1 m	Tower Jib Top
	3.0 m	Tower Insert Jib
	6.1 m	Tower Insert Jib

※ mark shows the standard tower jib arrangement which enables each tower jib length of less than that jib length to be configured.  
 ○ mark indicates the cable roller install position.

## Tower and Jib Combinations and Allowable Tower Angle

Tower length \ Jib length	16.8 m	19.8 m	22.9 m	25.9 m	29.0 m	Pillow plate	Add. weight*
21.0 m	90 °60 °	90 °60 °	—	—	—	—	x
24.1 m	90 °60 °	90 °60 °	90 °60 °	—	—	—	x
27.1 m	90 °60 °	90 °60 °	90 °60 °	90 °60 °	—	—	x
30.2 m	90 °60 °	90 °60 °	90 °60 °	90 °60 °	90 °70 °	—	x
33.2 m	90 °60 °	90 °60 °	90 °70 °	90 °70 °	90 °70 °	—	x
36.3 m	90 °60 °	90 °70 °	90 °70 °	90 °70 °	90 °70 °	—	x
39.3 m	90 °70 °	90 °70 °	90 °70 °	90 °70 °	90 °70 °	Need	x
42.4 m	90 °70 °	90 °70 °	90 °70 °	90 °70 °	90 °75 °	Need	Need
Hook						X	
19 ton hook							
Ball hook	x						
Jib Point Weight							
19 ton hook	Need	x	x	x	x		
Ball hook	x	Need	x	x	x		

\*Add. weight: Additional weight for self-erection

○ : Available  
 x : Not available



## Hook Blocks

A range of hook blocks can be specified, each with a safety latch.

Hooks	Weight (kg)	No. of sheaves	No. of lines and max. rated loads (tons)							
			1	2	3	4	5	6	7	8
55-ton	650	5	-	-	21.0	28.0	35.0	42.0	49.0	55.0
32-ton	500	2	-	-	21.0	28.0	32.0	-	-	-
19-ton	400	1	-	14.0	19.0	-	-	-	-	-
7-ton ball hook	160	0	7.0	-	-	-	-	-	-	-

## Symbols for Attachments:

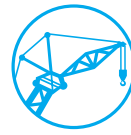

Crane Boom

Auxiliary Sheave  
for Crane Boom

Fixed Jib

Tower Jib

# WORKING RANGES AND LIFTING CAPACITIES

## Crane Boom Working Ranges

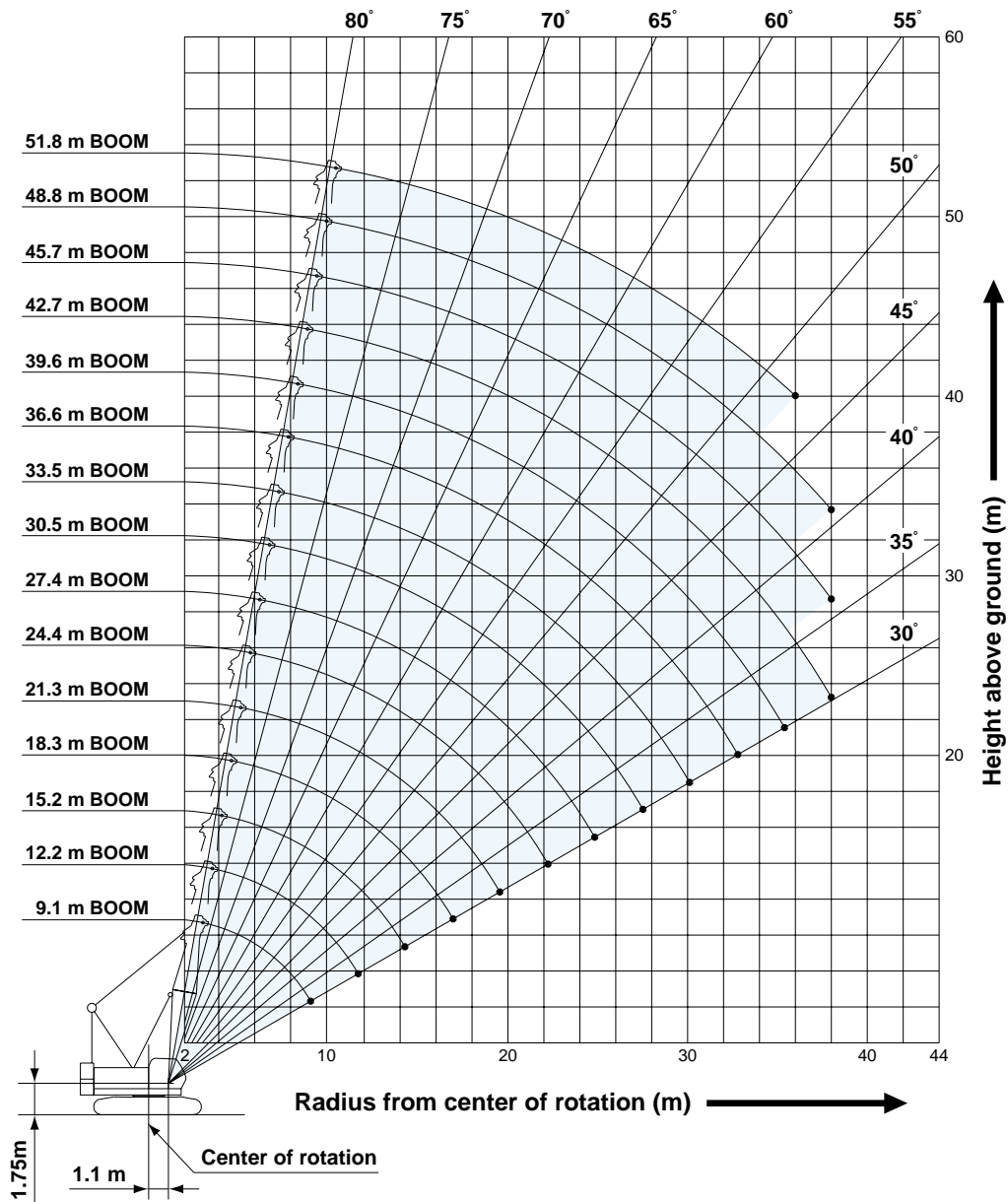

### NOTES:

- Ratings according to Japanese Construction Codes for Mobile Cranes and Japanese Safety Ordinance on Cranes, etc.
- Ratings in metric tons for 360° working area.
- Operating radius is the horizontal distance from center of rotation to a vertical line through the center of gravity of the load.
- Weight of hook block(s), slings and other load handling accessories is included in rated load. Their total weight must be subtracted from rated load to obtain weight that can be lifted.
- Ratings shown are based on freely suspended loads and make no allowance for such factors as wind effect on lifted load, ground conditions out-of-level, operating speeds or any other condition that could be detrimental to the safe operation of this equipment. Operator, therefore, has the responsibility to judge the existing conditions and reduce lifted loads and operating speeds accordingly.
- Ratings are for operation on a firm and level surface.
- At radii and boom lengths where no ratings are shown on chart, operation is not intended nor approved.
- Boom inserts and guy lines must be arranged as shown in the "Operator's Manual".
- Boom hoist reeving is 12 part line.
- Gantry must be in raised position for all conditions.
- Boom backstops are required for all boom lengths.
- Crawler frames must be fully extended for all crane operations.
- Ratings shown in   are determined by the strength of the boom or other structural component.
- Instruction in the "Operator's Manual" must be strictly observed when operating the machine.
- Crane boom ratings: Deduct weight of main hook block, slings, and all other load handling accessories from crane boom ratings shown.
- Auxiliary sheave ratings for crane boom: Deduct weight of ball hook, slings, and all other load handling accessories from auxiliary sheave ratings for crane boom shown.
- Crane boom lengths for auxiliary sheave mounting are 9.1 m to 48.8 m.
- Crane boom ratings with auxiliary sheave: Deduct 0.5 ton from crane boom ratings shown. Minimum rated loads must exceed 1.1 ton.

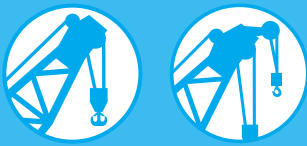

# Crane Boom Lifting Capacity

Unit: metric ton

**Counterweight: 15.2 t**

Working radius (m)	Boom length (m)															Boom length (m)	Working radius (m)	
		9.1	12.2	15.2	18.3	21.3	24.4	27.4	30.5	33.5	36.6	39.6	42.7	45.7	48.8			51.8
3.0	55.0	3.5 m/55.0																3.0
3.7	55.0	55.0																3.7
4.0	50.7	50.7	50.7	4.5 m/44.3														4.0
5.0	38.5	38.4	38.3	38.3	37.7	5.6 m/31.6												5.0
6.0	28.7	28.6	28.5	28.5	28.4	28.4	6.1 m/27.6	6.6 m/24.2										6.0
7.0	22.8	22.7	22.6	22.6	22.5	22.4	22.4	22.3	7.2 m/21.3	7.7 m/19.2								7.0
8.0	18.9	18.8	18.6	18.6	18.5	18.5	18.4	18.4	18.3	18.2	8.2 m/17.4	8.7 m/15.8						8.0
9.0	16.1	15.9	15.8	15.8	15.7	15.6	15.6	15.5	15.4	15.4	15.3	15.2	9.3 m/13.2	9.8 m/13.2				9.0
10.0	9.1 m/15.9	13.8	13.7	13.6	13.5	13.5	13.4	13.4	13.3	13.2	13.1	13.1	13.0	12.9	10.3 m/11.8			10.0
12.0		11.7 m/11.2	10.7	10.7	10.6	10.5	10.4	10.4	10.3	10.2	10.1	10.0	10.0	9.9	9.8			12.0
14.0			8.8	8.7	8.6	8.5	8.4	8.4	8.3	8.2	8.1	8.0	8.0	7.9	7.8			14.0
16.0			14.4 m/8.5	7.3	7.2	7.1	7.0	7.0	6.9	6.8	6.7	6.6	6.5	6.5	6.3			16.0
18.0				17.0 m/6.8	6.2	6.1	6.0	5.9	5.8	5.7	5.6	5.5	5.5	5.4	5.3			18.0
20.0					19.7 m/5.4	5.3	5.2	5.1	5.0	4.9	4.8	4.7	4.6	4.5	4.4			20.0
22.0						4.6	4.5	4.4	4.3	4.2	4.1	4.0	3.9	3.9	3.7			22.0
24.0						22.3 m/4.5	4.0	3.9	3.8	3.7	3.6	3.5	3.4	3.3	3.2			24.0
26.0							24.9 m/3.8	3.4	3.3	3.2	3.1	3.0	2.9	2.8	2.7			26.0
28.0								27.6 m/3.1	3.0	2.9	2.8	2.7	2.6	2.5	2.4			28.0
30.0									2.6	2.5	2.4	2.3	2.2	2.1	2.0			30.0
32.0									30.2 m/2.5	2.3	2.2	2.1	2.0	1.9	1.8			32.0
34.0										32.9 m/2.1	1.9	1.8	1.7	1.6	1.5			34.0
36.0											35.5 m/1.7	1.5	1.4	1.3	1.1			36.0
38.0												1.3	1.2	1.1				38.0
Reeves	8	8	8	7	6	5	4	4	4	3	3	3	2	2	2	2	2	Reeves

Note:  
 Ratings according to Japanese Construction Codes for Mobile Cranes and Japanese Safety Ordinance on Cranes, etc.  
 Ratings shown in   are determined by the strength of the boom or other structural components.  
 Refer to notes P10.

# Auxiliary Sheave Lifting Capacity for Crane Boom (With 19 t Main Hook)

Unit: metric ton

**Counterweight: 15.2 t**

Working radius (m)	Boom length (m)															Boom length (m)	Working radius (m)	
		9.1	12.2	15.2	18.3	21.3	24.4	27.4	30.5	33.5	36.6	39.6	42.7	45.7	48.8			
3.0	3.8 m/7.0																	3.8
4.0	7.0	4.3 m/7.0	4.8 m/7.0															4.0
5.0	7.0	7.0	7.0	5.4 m/7.0	5.9 m/7.0													5.0
6.0	7.0	7.0	7.0	7.0	7.0	6.4 m/7.0	6.9 m/7.0											6.0
7.0	7.0	7.0	7.0	7.0	7.0	7.0	7.0	7.5 m/7.0										7.0
8.0	7.0	7.0	7.0	7.0	7.0	7.0	7.0	7.0	7.0	8.5 m/7.0								8.0
9.0	7.0	7.0	7.0	7.0	7.0	7.0	7.0	7.0	7.0	7.0	9.1 m/7.0	9.6 m/7.0						9.0
10.0	9.1 m/7.0	7.0	7.0	7.0	7.0	7.0	7.0	7.0	7.0	7.0	7.0	7.0	10.1 m/7.0	10.6 m/7.0				10.0
12.0		11.7 m/7.0	7.0	7.0	7.0	7.0	7.0	7.0	7.0	7.0	7.0	7.0	7.0	7.0				12.0
14.0			7.0	7.0	7.0	7.0	7.0	7.0	7.0	7.0	7.0	7.0	7.0	7.0				14.0
16.0			14.4 m/7.0	6.6	6.5	6.4	6.3	6.3	6.2	6.1	6.0	5.9	5.8	5.8				16.0
18.0				17.0 m/6.1	5.5	5.4	5.3	5.2	5.1	5.0	4.9	4.8	4.8	4.7				18.0
20.0					19.7 m/4.7	4.6	4.5	4.4	4.3	4.2	4.1	4.0	3.9	3.8				20.0
22.0						3.9	3.8	3.7	3.6	3.5	3.4	3.3	3.2	3.2				22.0
24.0						22.3 m/3.8	3.3	3.2	3.1	3.0	2.9	2.8	2.7	2.6				24.0
26.0							24.9 m/3.1	2.7	2.6	2.5	2.4	2.3	2.2	2.1				26.0
28.0								27.6 m/2.4	2.3	2.2	2.1	2.0	1.9	1.8				28.0
30.0									1.9	1.8	1.7	1.6	1.5	1.4				30.0
32.0									30.2 m/1.8	1.6	1.5	1.4	1.3	1.2				32.0
34.0										32.9 m/1.4	1.2	1.1						34.0
Reeves	1	1	1	1	1	1	1	1	1	1	1	1	1	1	1	1	1	Reeves

Note:  
 Ratings according to Japanese Construction Codes for Mobile Cranes and Japanese Safety Ordinance on Cranes, etc.  
 Ratings shown in   are determined by the strength of the boom or other structural components.  
 Refer to notes P10.

## Fixed Jib Working Ranges

Jib Offset Angle: 10°, 30°

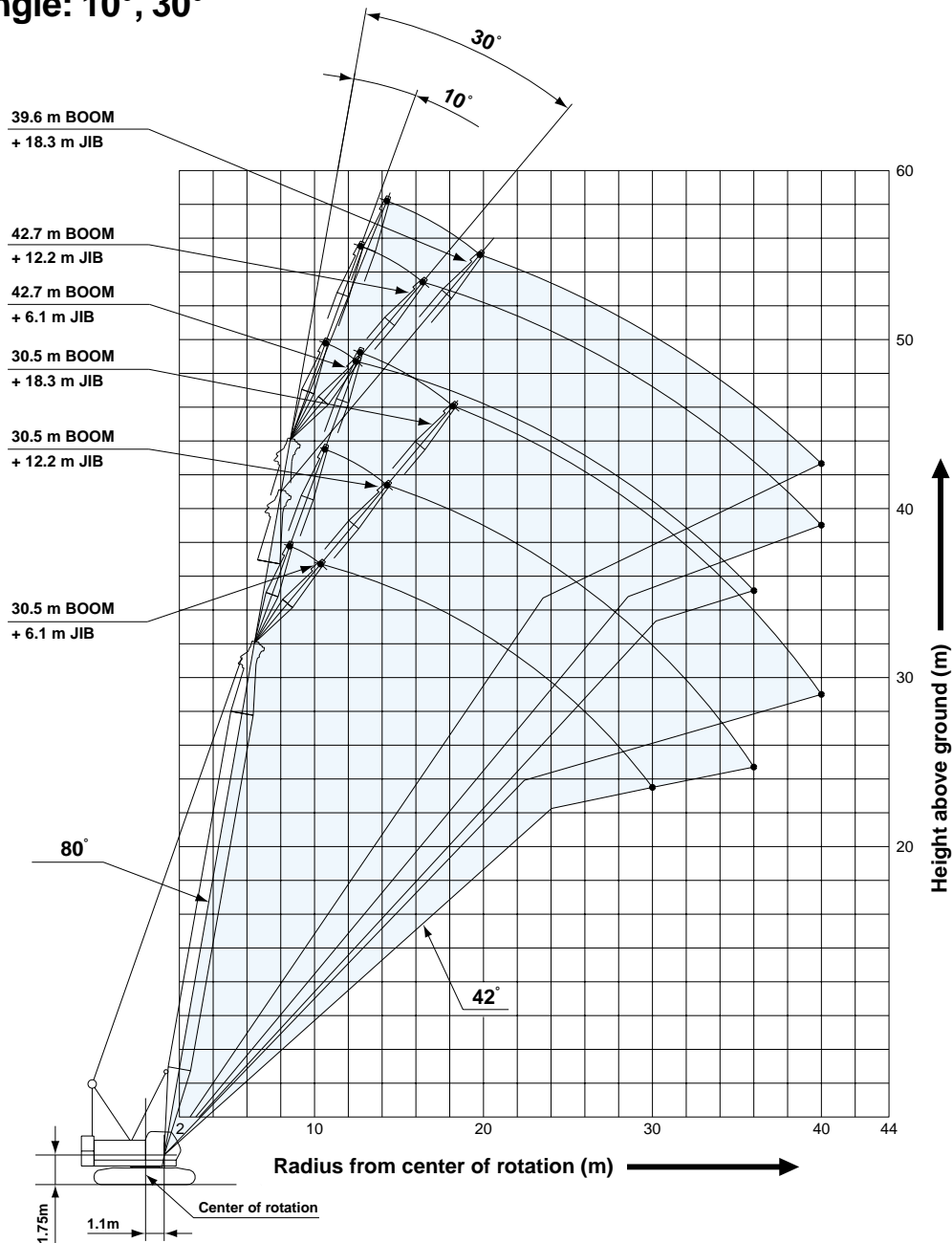

### NOTES:

1. Ratings according to Japanese Construction Codes for Mobile Cranes and Japanese Safety Ordinance on Cranes, etc.
2. Ratings in metric tons for 360° working area.
3. Operating radius is the horizontal distance from center of rotation to a vertical line through the center of gravity of the load.
4. Weight of hook block(s), slings and other load handling accessories is included in rated load. Their total weight must be subtracted from rated load to obtain weight that can be lifted.
5. Ratings shown are based on freely suspended loads and make no allowance for such factors as wind effect on lifted load, ground conditions out-of-level, operating speeds or any other condition that could be detrimental to the safe operation of this equipment. Operator, therefore, has the responsibility to judge the existing conditions and reduce lifted loads and operating speeds accordingly.
6. Ratings are for operation on a firm and level surface.
7. At radii and boom lengths where no ratings are shown on chart, operation is not intended nor approved.
8. Boom/ jib inserts and guy lines must be arranged as shown in the "Operator's Manual".
9. Gantry must be in raised position for all conditions.
10. Boom backstops are required for all boom lengths.
11. Crawler frames must be fully extended for all crane operations.
12. The boom should be erected over the front of crawlers, not laterally.
13. Ratings shown in  are determined by the strength of the boom or other structural component.
14. Instruction in the "Operator's Manual" must be strictly observed when operating the machine.
15. Fixed jib ratings: Deduct weight of jib hook block, slings, and all other load handling accessories from fixed jib ratings shown.
16. Crane boom lengths for fixed jib mounting are 30.5 m to 42.7 m.



# Fixed Jib Lifting Capacities (Without Main Hook)

Unit: metric ton

## Jib Offset Angle: 10°

Counterweight: 15.2 t

Boom length (m)	30.5			33.5			36.6			39.6			42.7		Boom length (m)	
Jib length (m)	6.1	12.2	18.3	6.1	12.2	18.3	6.1	12.2	18.3	6.1	12.2	18.3	6.1	12.2	Jib length (m)	
Working radius (m)	9.0	7.0		7.0											9.0	
	10.0	7.0		7.0			7.0			7.0					10.0	
	12.0	7.0	7.0	4.5	7.0	7.0		7.0	7.0		7.0			7.0	12.0	
	14.0	7.0	7.0	4.5	7.0	7.0	4.5	7.0	7.0	4.5	7.0	7.0	4.5	7.0	6.9	14.0
	16.0	6.9	7.0	4.5	6.8	7.0	4.5	6.7	7.0	4.5	6.6	6.9	4.5	6.6	6.5	16.0
	18.0	6.0	6.2	4.5	5.9	6.1	4.5	5.8	6.1	4.5	5.7	6.0	4.5	5.6	5.9	18.0
	20.0	5.1	5.3	4.5	5.0	5.2	4.5	4.9	5.2	4.5	4.8	5.1	4.5	4.7	5.0	20.0
	22.0	4.4	4.6	4.5	4.3	4.5	4.5	4.2	4.4	4.5	4.1	4.3	4.4	4.0	4.3	22.0
	24.0	3.8	4.0	4.1	3.7	3.9	4.0	3.7	3.9	3.9	3.5	3.8	3.8	3.5	3.7	24.0
	26.0	3.4	3.6	3.6	3.2	3.4	3.5	3.2	3.4	3.4	3.1	3.3	3.3	3.0	3.2	26.0
	28.0	3.0	3.1	3.2	2.8	3.0	3.1	2.8	3.0	3.0	2.7	2.8	2.9	2.5	2.8	28.0
	30.0	2.6	2.8	2.9	2.5	2.7	2.8	2.4	2.6	2.7	2.3	2.5	2.6	2.1	2.4	30.0
	32.0	2.3	2.5	2.6	2.2	2.4	2.5	2.1	2.3	2.4	1.9	2.2	2.3	1.8	2.0	32.0
	34.0		2.2	2.3	1.9	2.1	2.2	1.8	2.0	2.1	1.6	1.8	1.9	1.5	1.7	34.0
	36.0		2.0	2.1	1.6	1.8	1.9	1.5	1.7	1.8	1.3	1.6	1.7	1.2	1.4	36.0
	38.0		1.7	1.8		1.6	1.7	1.2	1.5	1.6	1.1	1.3	1.4		1.2	38.0
40.0			1.6		1.4	1.5		1.2	1.4		1.1	1.2			40.0	
Reeves	1	1	1	1	1	1	1	1	1	1	1	1	1	1	Reeves	

Note:

Ratings according to Japanese Construction Codes for Mobile Cranes and Japanese Safety Ordinance on Cranes, etc.

Ratings shown in   are determined by the strength of the boom or other structural components.

Refer to notes P12.

Unit: metric ton

## Jib Offset Angle: 30°

Counterweight: 15.2 t

Boom length (m)	30.5			33.5			36.6			39.6			42.7		Boom length (m)	
Jib length (m)	6.1	12.2	18.3	6.1	12.2	18.3	6.1	12.2	18.3	6.1	12.2	18.3	6.1	12.2	Jib length (m)	
Working radius (m)	12.0	7.0		7.0			7.0			7.0					12.0	
	14.0	7.0		7.0			7.0			7.0			6.8		14.0	
	16.0	7.0	5.0		7.0	5.0		7.0	5.0		6.9	5.0		6.6	16.0	
	18.0	6.2	5.0	3.2	6.1	5.0	3.2	6.0	5.0		5.9	5.0		5.9	4.6	18.0
	20.0	5.3	5.0	3.2	5.2	5.0	3.2	5.1	5.0	3.2	5.0	5.0	3.2	4.9	4.4	20.0
	22.0	4.5	4.9	3.2	4.4	4.8	3.2	4.4	4.7	3.2	4.3	4.7	3.2	4.2	4.3	22.0
	24.0	3.9	4.2	3.2	3.8	4.2	3.2	3.8	4.1	3.2	3.7	4.0	3.2	3.6	4.0	24.0
	26.0	3.4	3.7	3.2	3.3	3.6	3.2	3.3	3.6	3.2	3.2	3.5	3.2	3.1	3.4	26.0
	28.0	3.0	3.3	3.2	2.9	3.2	3.2	2.9	3.1	3.2	2.7	3.1	3.2	2.7	3.0	28.0
	30.0	2.7	2.9	3.1	2.6	2.8	3.0	2.5	2.8	3.0	2.4	2.7	2.9	2.3	2.6	30.0
	32.0		2.6	2.8	2.2	2.5	2.7	2.2	2.4	2.6	2.0	2.3	2.5	1.9	2.3	32.0
	34.0		2.3	2.5		2.2	2.4	1.8	2.1	2.3	1.7	2.0	2.2	1.6	1.9	34.0
	36.0		2.0	2.2		1.9	2.1		1.9	2.1	1.4	1.7	2.0	1.3	1.6	36.0
	38.0			2.0		1.7	1.9		1.6	1.8	1.1	1.5	1.7		1.3	38.0
	40.0			1.8			1.7		1.3	1.6		1.2	1.4		1.1	40.0
	Reeves	1	1	1	1	1	1	1	1	1	1	1	1	1	1	Reeves

Note:

Ratings according to Japanese Construction Codes for Mobile Cranes and Japanese Safety Ordinance on Cranes, etc.

Ratings shown in   are determined by the strength of the boom or other structural components.

Refer to notes P12.



# Tower Jib Working Ranges

**Tower Length: 36.3 m**

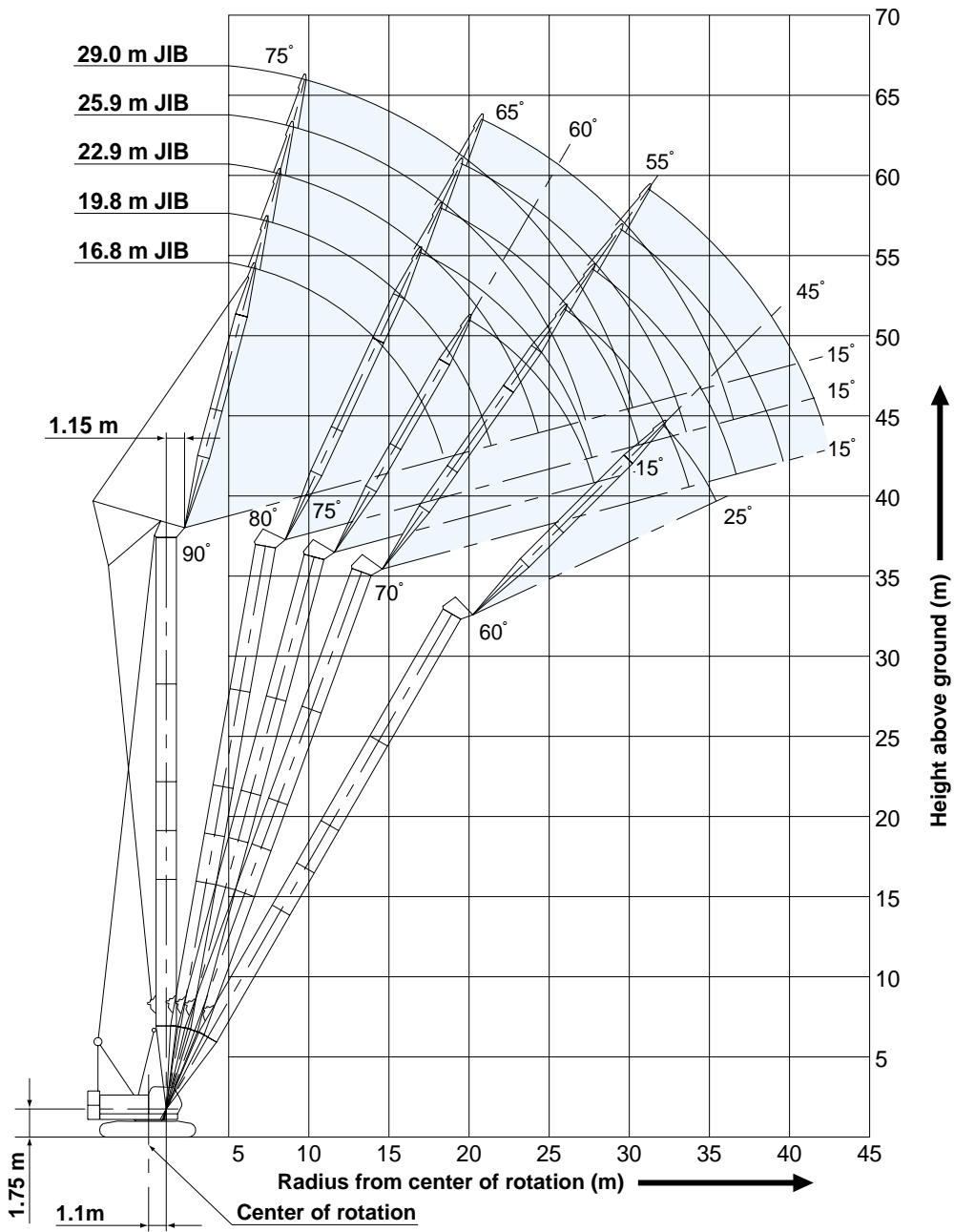

**NOTES:**

1. Ratings according to Japanese Construction Codes for Mobile Cranes and Japanese Safety Ordinance on Cranes, etc.
2. Ratings in metric tons for 360° working area.
3. Operating radius is the horizontal distance from center of rotation to a vertical line through the center of gravity of the load.
4. Weight of hook block(s), slings and other load handling accessories is included in rated load. Their total weight must be subtracted from rated load to obtain weight that can be lifted.
5. Ratings shown are based on freely suspended loads and make no allowance for such factors as wind effect on lifted load, ground conditions out-of-level, operating speeds or any other condition that could be detrimental to the safe operation of this equipment. Operator, therefore, has the responsibility to judge the existing conditions and reduce lifted loads and operating speeds accordingly.
6. Ratings are for operation on a firm and level surface.
7. At radii and boom lengths where no ratings are shown on chart, operation is not intended nor approved.
8. Tower/tower jib inserts and guy lines must be arranged as shown in the "Operator's Manual".
9. Tower jib hoist reeving is 8 part line.
10. Gantry must be in raised position for all conditions.
11. Crawlers must be fully extended for all crane operations.



## Tower Length: 42.4 m

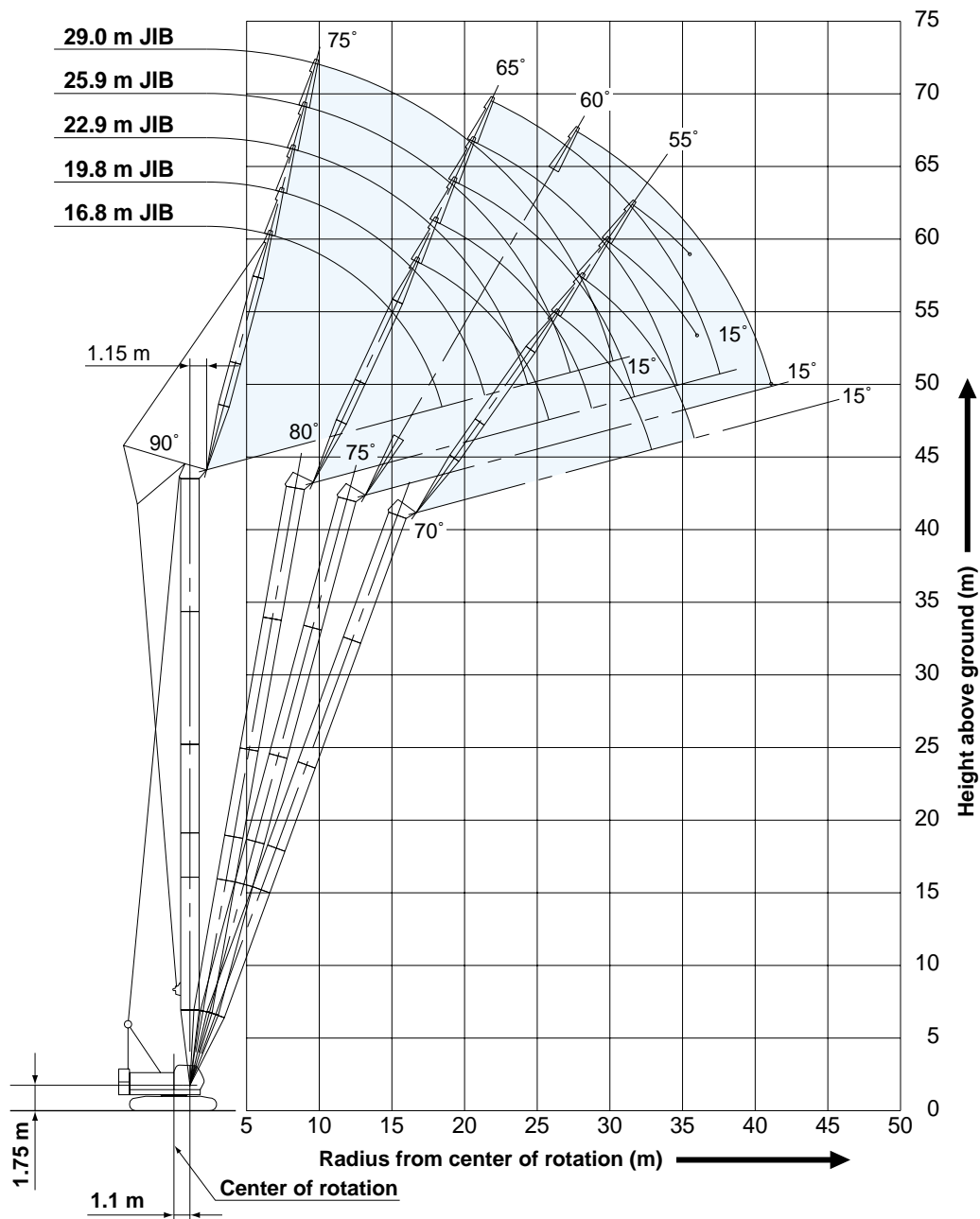

12. Tower and tower jib backstops are required for all tower and tower jib combinations.
13. Ratings shown in  are determined by the strength of the tower or other structural component.
14. With a 16.8 m tower jib, a 7-ton ball hook cannot be used.
15. When erecting and lowering the tower length of 39.3 m or over, the pillow plate for erection must be placed at the end of crawlers.
16. For the erection and dismantling of a 42.4 m tower, an additional weight for erection use (3.3 ton) must be used. Additional weight for self-erection should be removed during crane operation.
17. When using a 19-ton hook with a 16.8 m tower jib, or a 7-ton ball hook with a 19.8 m tower jib, attach a tower jib point weight (300 kg).
18. Instruction in the "Operator's Manual" must be strictly observed when operating the machine.
19. Tower jib ratings: Deduct weight of hook block, slings, and all other load handling accessories from tower jib ratings shown.



# Tower Jib Lifting Capacities

Unit: metric ton

**Counterweight: 15.2 t**

21.0 m Tower Length	Tower length (m)	21.0						Tower length (m)
	Jib length (m)	16.8			19.8			Jib length (m)
	Tower angle	90°	75°	60°	90°	75°	60°	Tower angle
Working Radius (m)	6.0	6.5 m/12.0						6.0
	7.0	12.0			7.3 m/12.0			7.0
	8.0	12.0			12.0			8.0
	9.0	12.0			12.0			9.0
	10.0	12.0			11.8			10.0
	12.0	10.7			10.5			12.0
	14.0	9.6	15.9 m/7.4		9.4			14.0
	16.0	8.2	7.3		8.1	17.5 m/6.5		16.0
	18.0	6.2	6.4		7.1	6.3		18.0
	20.0	18.3 m/5.5	5.6		5.9	5.5		20.0
	22.0		5.0		21.3 m/4.6	4.9		22.0
	24.0		23.7 m/4.5	24.4 m/3.8		4.4		24.0
	26.0			3.5		4.0	26.5 m/3.3	26.0
	28.0			3.2		26.7 m/3.8	3.1	28.0
	30.0			28.7 m/3.1			2.8	30.0
32.0						31.6 m/2.6	32.0	
	Reeves	2			2			Reeves

24.1 m Tower Length	Tower length (m)	24.1									Tower length (m)
	Jib length (m)	16.8			19.8			22.9			Jib length (m)
	Tower angle	90°	75°	60°	90°	75°	60°	90°	75°	60°	Tower angle
Working Radius (m)	6.0	6.5 m/12.0									6.0
	7.0	12.0			7.3 m/12.0						7.0
	8.0	12.0			12.0			8.1 m/11.5			8.0
	9.0	12.0			12.0			11.2			9.0
	10.0	12.0			11.8			11.0			10.0
	12.0	10.7			10.5			10.3			12.0
	14.0	9.6			9.4			9.2			14.0
	16.0	8.2	16.7 m/6.7		8.1			8.1			16.0
	18.0	6.2	6.2		7.2	18.3 m/6.0		7.2	19.8 m/5.3		18.0
	20.0	18.3 m/5.5	5.4		5.9	5.3		6.3	5.3		20.0
	22.0		4.8		21.3 m/4.6	4.7		5.3	4.7		22.0
	24.0		4.3	25.9 m/3.3		4.3		4.1	4.2		24.0
	26.0		24.6 m/4.2	3.2		3.8		24.2 m/3.9	3.8		26.0
	28.0			2.9		27.5 m/3.6	28.1 m/2.8		3.5		28.0
	30.0			2.7			2.6		3.2	30.2 m/2.5	30.0
32.0			30.3 m/2.7			2.4		30.4 m/3.1	2.3	32.0	
34.0						33.2 m/2.3			2.1	34.0	
36.0									2.0	36.0	
38.0									36.2 m/2.0	38.0	
	Reeves	2			2			2			Reeves

Note:  
 Ratings according to Japanese Construction Codes for Mobile Cranes and Japanese Safety Ordinance on Cranes, etc.  
 Ratings shown in   are determined by the strength of the tower or other structural components.  
 Refer to notes P15 and P16.

# HYDRAULIC CRAWLER CRANE 7055

Unit: metric ton

Counterweight: 15.2 t

27.1 m Tower Length	Tower length (m)		27.1												Tower length (m)	
	Jib length (m)		16.8			19.8			22.9			25.9			Jib length (m)	
	Tower angle		90°	75°	60°	90°	75°	60°	90°	75°	60°	90°	75°	60°	Tower angle	
Working Radius (m)	6.0	6.5 m/12.0														6.0
	7.0	12.0				7.3 m/12.0										7.0
	8.0	12.0				12.0				8.1 m/11.5			8.9 m/8.6			8.0
	9.0	12.0				12.0				11.2			8.6			9.0
	10.0	12.0				11.8				11.0			8.4			10.0
	12.0	10.7				10.4				10.3			8.2			12.0
	14.0	9.5				9.3				9.2			7.7			14.0
	16.0	8.2	17.5 m/6.2			8.1				8.1			7.1			16.0
	18.0	6.2	6.0			7.2	19.0 m/5.5			7.2			6.5			18.0
	20.0	18.3 m/5.5	5.3			5.9	5.2			6.3	20.6 m/4.9		5.9			20.0
	22.0		4.7			21.3 m/4.6	4.6			5.3	4.5		5.3	22.1 m/4.4		22.0
	24.0		4.2				4.1			4.1	4.0		4.7	4.0		24.0
	26.0		25.3 m/3.9	27.4 m/2.8			3.7			24.2 m/3.9	3.7		4.0	3.6		26.0
	28.0			2.7			3.4	29.6 m/2.4			3.3		27.2 m/3.3	3.2		28.0
	30.0			2.5			28.3 m/3.3	2.3			3.0	31.7 m/2.1		3.0		30.0
	32.0			31.8 m/2.3				2.1			31.2 m/2.9	2.0		2.7	33.9 m/1.7	32.0
	34.0							1.9				1.9		2.5	1.7	34.0
	36.0							34.7 m/1.9				1.7		34.2 m/2.5	1.6	36.0
38.0											37.6 m/1.6			1.4	38.0	
40.0														1.3	40.0	
42.0														40.6 m/1.3	42.0	
Reeves		2				2				2			2		Reeves	

30.2 m Tower Length	Tower length (m)		30.2															Tower length (m)	
	Jib length (m)		16.8			19.8			22.9			25.9			29.0			Jib length (m)	
	Tower angle		90°	75°	60°	90°	75°	60°	90°	75°	60°	90°	75°	60°	90°	80°	70°	Tower angle	
Working Radius (m)	6.0	6.5 m/12.0																6.0	
	7.0	12.0				7.3 m/12.0												7.0	
	8.0	12.0				12.0				8.1 m/11.5			8.9 m/8.6					8.0	
	9.0	12.0				12.0				11.2			8.6			9.7 m/6.2		9.0	
	10.0	12.0				11.8				11.0			8.4			6.2		10.0	
	12.0	10.6				10.4				10.3			8.2			6.2		12.0	
	14.0	9.5				9.3				9.2			7.7			6.0		14.0	
	16.0	8.2				8.1				8.1			7.1			5.6		16.0	
	18.0	6.2	18.3 m/5.7			7.2	19.8 m/5.0			7.2			6.4			5.1	19.6 m/5.4		18.0
	20.0	18.3 m/5.5	5.1			5.9	5.0			6.3	21.4 m/4.5		5.9			4.6	5.2		20.0
	22.0		4.5			21.3 m/4.6	4.4			5.3	4.4		5.3	22.9 m/4.0		4.2	4.6		22.0
	24.0		4.0				4.0			4.1	3.9		4.7	3.8		3.8	4.1		24.0
	26.0		3.7				3.6			24.2 m/3.9	3.5		4.0	3.4		3.5	3.7		26.0
	28.0		26.1 m/3.6	28.9 m/2.3			3.2				3.2		27.2 m/3.3	3.1		3.2	3.4	29.0 m/2.6	28.0
	30.0			2.2			29.1 m/3.1	31.1 m/1.9			2.9			2.8		2.8	3.1	2.5	30.0
	32.0			2.0				1.8			2.7	33.3 m/1.6		2.6		30.1 m/2.8	2.8	2.3	32.0
	34.0			33.3 m/1.8				1.7				1.6		2.4	35.4 m/1.3		2.6	2.0	34.0
	36.0							1.5				1.4		34.9 m/2.3	1.3		35.3 m/2.5	1.9	36.0
38.0							36.2 m/1.5				1.3			1.2			1.7	38.0	
40.0											39.2 m/1.2			1.1			1.6	40.0	
42.0																	40.4 m/1.5	42.0	
Reeves		2				2				2			2		1			Reeves	

Note:  
 Ratings according to Japanese Construction Codes for Mobile Cranes and Japanese Safety Ordinance on Cranes, etc.  
 Ratings shown in   are determined by the strength of the tower or other structural components.  
 Refer to notes P15 and P16.

Unit: metric ton

Counterweight: 15.2 t

33.2 m Tower Length	33.2																
	Tower length (m)	33.2														Tower length (m)	
	Jib length (m)	16.8			19.8			22.9			25.9			29.0			Jib length (m)
Working Radius (m)	Tower angle	90°	75°	60°	90°	75°	60°	90°	80°	70°	90°	80°	70°	90°	80°	70°	Tower angle
6.0	6.5 m/12.0																6.0
7.0	12.0				7.3 m/12.0												7.0
8.0	12.0				12.0			8.1 m/11.5			8.9 m/8.6						8.0
9.0	12.0				12.0			11.2			8.6			9.7 m/6.2			9.0
10.0	12.0				11.8			11.0			8.3			6.2			10.0
12.0	10.6				10.4			10.3			8.0			6.2			12.0
14.0	9.5				9.3			9.2			7.7			6.0			14.0
16.0	8.2				8.1			8.1	17.6 m/6.2		7.1			5.6			16.0
18.0	6.2	19.1 m/5.2			7.2			7.2	6.0		6.4	18.9 m/5.5		5.1			18.0
20.0	18.3 m/5.5	4.9			5.9	20.6 m/4.6		6.3	5.2		5.8	5.1		4.6	20.1 m/5.0		20.0
22.0		4.3			21.3 m/4.6	4.2		5.3	4.7		5.3	4.6		4.2	4.5		22.0
24.0		3.9				3.8		4.1	4.2		4.7	4.1		3.8	4.0		24.0
26.0		3.5				3.4		24.2 m/3.9	3.8	26.6 m/2.9	4.0	3.7		3.5	3.6		26.0
28.0		26.9 m/3.3				3.1			3.4	2.7	27.2 m/3.3	3.3	28.3 m/2.5	3.1	3.3		28.0
30.0			30.5 m/1.8			29.8 m/2.8			3.1	2.4		3.1	2.3	2.8	3.0	30.1 m/2.2	30.0
32.0			1.6				32.6 m/1.4			2.2		2.8	2.1	30.1 m/2.8	2.7	2.0	32.0
34.0			1.5				1.3			2.0		32.9 m/2.7	1.9		2.5	1.8	34.0
36.0			34.8 m/1.4				1.2			35.5 m/1.9			1.7		35.9 m/2.3	1.6	36.0
38.0							37.7 m/1.1						1.6			1.5	38.0
40.0													38.5 m/1.5			1.4	40.0
42.0																41.4 m/1.3	42.0
Reeves		2			2			2			2			1			Reeves

36.3 m Tower Length	36.3																
	Tower length (m)	36.3														Tower length (m)	
	Jib length (m)	16.8			19.8			22.9			25.9			29.0			Jib length (m)
Working Radius (m)	Tower angle	90°	75°	60°	90°	80°	70°	90°	80°	70°	90°	80°	70°	90°	80°	70°	Tower angle
6.0	6.5 m/12.0																6.0
7.0	12.0				7.3 m/11.4												7.0
8.0	12.0				11.4			8.1 m/10.1			8.9 m/8.6						8.0
9.0	12.0				11.4			10.1			8.5			9.7 m/6.2			9.0
10.0	12.0				11.4			10.1			8.3			6.2			10.0
12.0	10.6				10.4			10.1			8.0			6.2			12.0
14.0	9.5				9.3			9.2			7.7			6.0			14.0
16.0	8.2				8.1	16.8 m/6.4		8.1			7.1			5.6			16.0
18.0	6.2	19.9 m/4.7			7.2	5.9		7.2	18.1 m/5.8		6.4	19.4 m/5.2		5.1			18.0
20.0	18.3 m/5.5	4.7			5.9	5.2		6.3	5.1		5.8	5.0		4.6	20.7 m/4.4		20.0
22.0		4.1			21.3 m/4.6	4.6		5.3	4.5		5.3	4.4		4.2	4.4		22.0
24.0		3.7				4.1	25.9 m/2.8	4.1	4.1		4.7	4.0		3.8	3.9		24.0
26.0		3.4				3.7	2.8	24.2 m/3.9	3.7	27.6 m/2.5	3.9	3.6		3.5	3.5		26.0
28.0		27.7 m/3.1				27.6 m/3.4	2.5		3.3	2.4	27.2 m/3.3	3.2	29.4 m/2.1	3.1	3.2		28.0
30.0							2.3		3.0	2.2		3.0	2.1	2.8	2.9	31.1 m/1.9	30.0
32.0			1.3				2.1		30.5 m/3.0	2.0		2.7	1.9	30.1 m/2.8	2.7	1.8	32.0
34.0			1.2				33.6 m/1.9			1.8		33.5 m/2.5	1.7		2.4	1.6	34.0
36.0			35.3 m/1.1							1.6			1.5		2.3	1.4	36.0
38.0										36.6 m/1.6			1.4		36.4 m/2.2	1.3	38.0
40.0													39.5 m/1.3			1.2	40.0
42.0																1.1	42.0
Reeves		2			2			2			2			1			Reeves

Note:  
 Ratings according to Japanese Construction Codes for Mobile Cranes and Japanese Safety Ordinance on Cranes, etc.  
 Ratings shown in   are determined by the strength of the tower or other structural components.  
 Refer to notes P15 and P16.

# HYDRAULIC CRAWLER CRANE 7055

Unit: metric ton

Counterweight: 15.2 t

39.3 m Tower Length	39.3																Tower length (m)		
	Tower length (m)		16.8			19.8			22.9			25.9			29.0			Tower length (m)	
	Jib length (m)	Tower angle	90°	80°	70°	90°	80°	70°	90°	80°	70°	90°	80°	70°	90°	80°	70°	Jib length (m)	Tower angle
Working Radius (m)	6.0	6.5 m/11.4																	6.0
	7.0	11.4				7.3 m/9.5													7.0
	8.0	11.4				9.5			8.1 m/8.1			8.9 m/6.7							8.0
	9.0	11.4				9.5			8.1			6.7			9.7 m/6.2				9.0
	10.0	11.0				9.5			8.1			6.7			6.2				10.0
	12.0	10.4				9.5			8.1			6.7			6.2				12.0
	14.0	9.5				9.2			8.1			6.7			6.0				14.0
	16.0	8.2	6.7			8.1	17.3 m/6.0		8.1			6.7			5.6				16.0
	18.0	6.2	5.8			7.2	5.7		7.2	18.6 m/5.4		6.4	19.9 m/4.9		5.0				18.0
	20.0	18.3 m/5.5	5.1			5.9	5.0		6.3	4.9		5.8	4.8		4.6	21.2 m/4.4			20.0
	22.0		4.5			21.3 m/4.6	4.4		5.3	4.4		5.3	4.3		4.2	4.2			22.0
	24.0		4.1	25.1 m/2.8			4.0		4.1	3.9		4.7	3.8		3.8	3.8			24.0
	26.0			25.1 m/3.8	2.6		3.6	26.9 m/2.4	24.2 m/3.9	3.5		3.9	3.5		3.4	3.4			26.0
	28.0				2.4		3.3	2.2		3.2	28.6 m/2.1	27.2 m/3.3	3.1		3.1	3.1			28.0
	30.0				2.1			28.1 m/3.2	2.0	2.9	1.9		2.9	30.4 m/1.7	2.8	2.8			30.0
	32.0				31.7 m/1.9				1.8	31.0 m/2.8	1.7		2.6	1.6	30.1 m/2.8	2.6	32.1 m/1.5		32.0
	34.0								1.6		1.6		2.4	1.4		2.3	1.3		34.0
	36.0							34.7 m/1.6			1.4		1.3			2.2	1.2		36.0
	38.0										37.6 m/1.3			1.1		36.9 m/2.1	1.1		38.0
	40.0													39.0 m/1.1					40.0
Reeves			2			2			2			1			1			Reeves	

42.4 m Tower Length	42.4																Tower length (m)		
	Tower length (m)		16.8			19.8			22.9			25.9			29.0			Tower length (m)	
	Jib length (m)	Tower angle	90°	80°	70°	90°	80°	70°	90°	80°	70°	90°	80°	70°	90°	80°	75°	Jib length (m)	Tower angle
Working Radius (m)	6.0	6.5 m/9.9																	6.0
	7.0	9.9				7.3 m/8.2													7.0
	8.0	9.9				8.2			8.1 m/7.7			8.9 m/6.5							8.0
	9.0	9.9				8.2			7.7			6.5			9.7 m/6.0				9.0
	10.0	9.9				8.2			7.7			6.5			6.0				10.0
	12.0	9.0				8.2			7.7			6.5			6.0				12.0
	14.0	8.2				7.9			7.7			6.4			6.0				14.0
	16.0	7.3	16.6 m/6.2			7.5	17.9 m/5.6		7.4			6.3			5.6				16.0
	18.0	6.2	5.7			6.8	5.5		7.2	19.2 m/5.1		6.2			5.0				18.0
	20.0	18.3 m/5.5	5.0			5.8	4.9		6.3	4.8		5.8	20.4 m/4.6		4.6	21.7 m/4.1			20.0
	22.0		4.4			21.3 m/4.6	4.3		5.2	4.2		5.3	4.1		4.1	4.1			22.0
	24.0		3.9				3.9		4.1	3.8		4.7	3.7		3.8	3.6			24.0
	26.0			25.7 m/3.6	26.2 m/2.3		3.5	27.9 m/1.9	24.2 m/3.9	3.4		3.9	3.3		3.4	3.3	27.6 m/2.4		26.0
	28.0				2.1		3.2	1.9		3.1	29.7 m/1.7	27.2 m/3.3	3.0		3.1	3.0	2.3		28.0
	30.0				1.9			28.6 m/3.1	1.7	2.8	1.6		2.8	31.4 m/1.4	2.8	2.7	2.1		30.0
	32.0				1.7				1.6	31.6 m/2.6	1.5		2.5	1.3	30.1 m/2.8	2.5	1.9		32.0
	34.0				32.8 m/1.6				1.4		1.3		2.3	1.2		2.3	1.7		34.0
	36.0							35.7 m/1.3			1.2		34.5 m/2.3	35.5 m/1.1		2.1	1.5		36.0
	38.0										1.1					37.5 m/2.0	1.4		38.0
	40.0																1.2		40.0
42.0																41.1 m/1.2		42.0	
Reeves			2			2			2			1			1			Reeves	

Note:  
 Ratings according to Japanese Construction Codes for Mobile Cranes and Japanese Safety Ordinance on Cranes, etc.  
 Ratings shown in   are determined by the strength of the tower or other structural components.  
 Refer to notes P15 and P16.

# PARTS AND ATTACHMENTS

## Base Machine

With boom base, crawlers, gantry, lower spreader, upper spreader, and wire rope for main & boom hoist winches  
 Weight: 40,200 kg Width: 3,200 mm

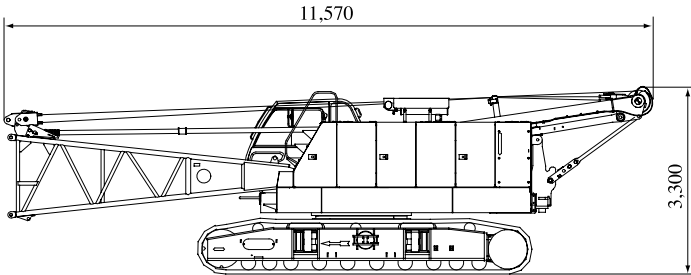

## Crawler

Weight: 6,500 kg

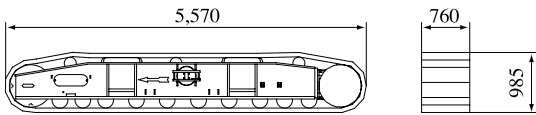

## Counterweight A

Weight: 7,510 kg

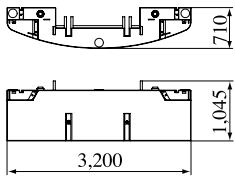

## Counterweight B

Weight: 7,730 kg

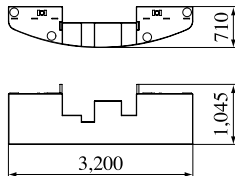

## Insert Boom

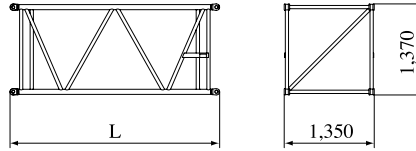

	L (mm)	Weight (kg)*
3.0m	3,145	320
6.1m	6,190	520
9.1m	9,240	730

\*with boom guy cables

## Boom Base

Weight: 980 kg

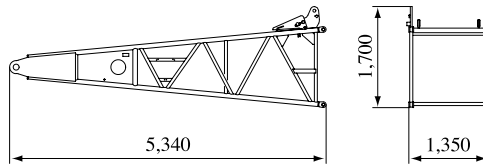

## Boom Top

Weight: 1,070 kg (with boom guy cables)

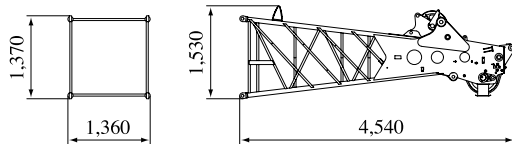

## 9.1 m Special Insert Boom for Tower

Weight: 1,190 kg (with boom guy cables)

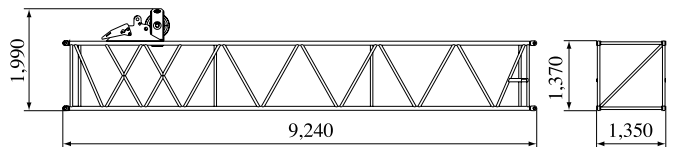

## Tower Cap

Weight: 600 kg

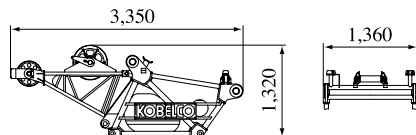

# HYDRAULIC CRAWLER CRANE 7055

Dimensions: mm Weight: kg

## Jib Base (For Crane)

Weight: 125 kg

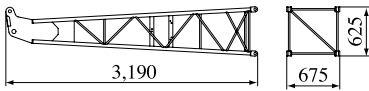

## Tower Jib Base

Weight: 400 kg

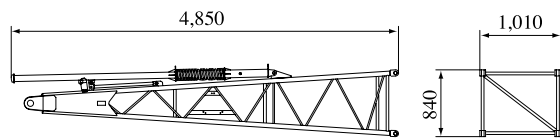

## Jib Top (For Crane)

Weight: 145 kg

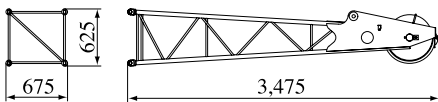

## Tower Jib Top

Weight: 245 kg

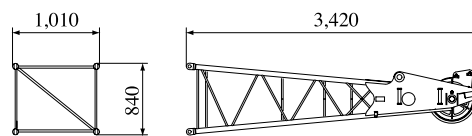

## Insert Tower Jib

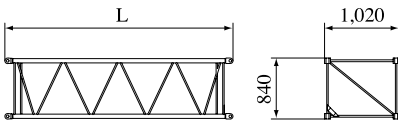

## Tower Jib strut

Weight: 760 kg

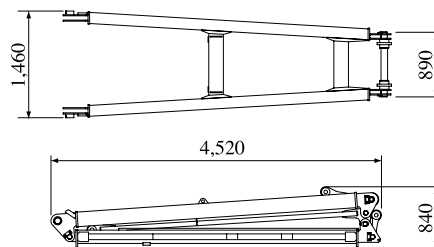

	L (mm)	Weight (kg)
3.0 m	3,120	115
6.1 m	6,170	195

## Other Attachments

Attachments	Weight	Dimensions (L x W x H)
6.1 m insert boom with lug	540 kg (with guy cables)	6,190 mm x 1,350 mm x 1,500 mm
9.1 m insert boom with lug	750 kg (with guy cables)	9,240 mm x 1,350 mm x 1,500 mm
6.1 m insert jib (for crane)	140 kg	6,160 mm x 675 mm x 625 mm
Jib strut (for crane)	190 kg	3,700 mm x 670 mm x 500 mm
Auxiliary sheave	140 kg	1,325 mm x 540 mm x 1,285 mm
Upper spreader for boom hoist	280 kg	1,460 mm x 300 mm x 630 mm
Upper spreader for tower jib	225 kg	640 mm x 610 mm x 775 mm
Lower spreader for tower jib	335 kg	1,350 mm x 450 mm x 930 mm
55-ton hook	650 kg	590 mm x 435 mm x 1,470 mm
32-ton hook	500 kg	590 mm x 330 mm x 1,530 mm
19-ton hook	400 kg	590 mm x 385 mm x 1,270 mm
7-ton ball hook	160 kg	ø 300 mm x 815 mm

Note: Estimated weights may vary ± 2%.

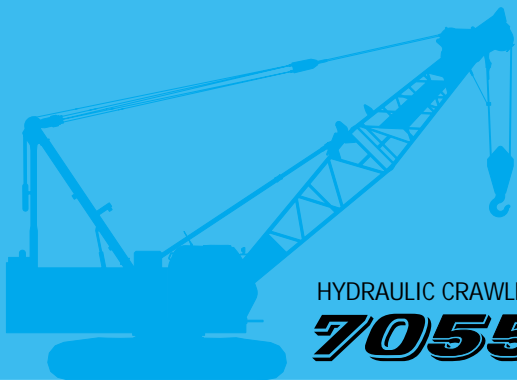

HYDRAULIC CRAWLER CRANE

**7055**

## Standard Equipment

### Upper structure/Lower structure

Counterweight: 15.2 ton (total weight)  
760 mm shoe crawlers  
Batteries (2-12V, 136 Ah/5 HR)  
Gantry raising/lowering cylinder  
Electric hand throttle grip  
Variable boom hoist speed controller  
Variable main/aux. hoist speed controller  
Swing neutral-free/brake select switch  
Side deck for cab  
Steps (crawlers)  
Two front working lights  
Two rear view mirrors  
Tools (for routine maintenance)  
Cable roller (for boom)  
Upper spreader storage guide

### Cab Control

Air conditioner  
Luggage box  
Cup holder  
Ashtray  
Cigar lighter  
Intermittent wiper & window washer (skylight and front window)  
Sun visor  
Roof blind  
Floor mat (cloth)  
Foot rest  
Shoe tray

### Safety Device

Load Moment Indicator (with boom lowering slow stop function)  
LMI release key (for hook over-hoist prevention device and boom over-hoist prevention device)  
LCD multi display  
Ultimate stop function for boom over-hoist  
Function lock lever  
Propel lever lock  
Mechanical drum lock pawl (main, aux. and boom hoist)  
Signal horn  
Swing parking brake  
Mechanical swing lock pin (two positions)  
Swing flashers/warning buzzer

**Note:** Due to our policy of continual product improvements all designs and specifications are subject to change without advance notice.  
Copyright by KOBELCO CRANES CO., LTD. No part of this catalog may be reproduced in any manner without notice.

## KOBELCO CRANES CO., LTD.

17-1, Higashigotanda 2-chome, Shinagawa-ku, Tokyo 141-8626 JAPAN  
Tel: +81-3-5789-2130 Fax: +81-3-5789-3372

Inquiries To:

KOBELCO is the corporate mark used by Kobe Steel on a variety of products and in the names of a number of Kobe Steel Group companies.

Bulletin No. 7055-3FSPEC-AO1 0609011F Printed in Japan