

Hydraulic Crawler Crane

CKS

1000

Model : CKS1000

Max. Lifting Capacity: **100 t*** x **3.3 m**

Max. Crane Boom Length: **61.0 m**

Max. Fixed Jib Combination: **51.8 m + 18.3 m**

* The value are theoretical result.

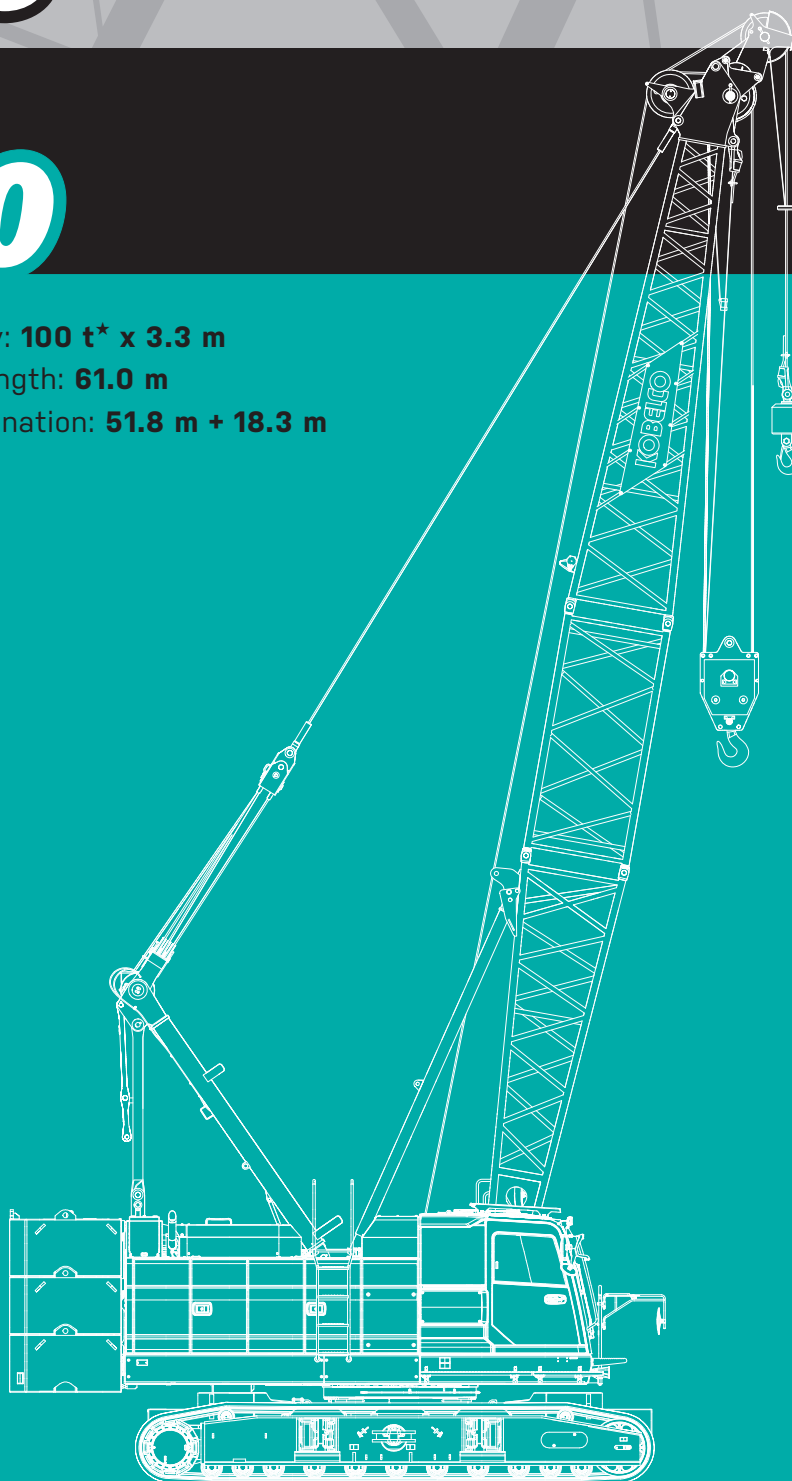

KOBELCO



CKS1000 CONTENTS

3 SPECIFICATIONS

5 GENERAL DIMENSIONS

6 BOOM AND JIB ARRANGEMENTS

7 WORKING RANGES

10 SUPPLEMENTAL DATA

11 LIFTING CAPACITIES

16 SUPPLEMENTAL DATA FOR CLAMSHELL

17 LIFTING CAPACITIES

18 SUPPLEMENTAL DATA FOR REDUCED WEIGHTS

19 LIFTING CAPACITIES

20 SUPPLEMENTAL DATA FOR BARGE

21 LIFTING CAPACITIES

22 TRANSPORTATION PLAN

25 PARTS AND ATTACHMENTS

SPECIFICATIONS



Power Plant

Model: HINO J08E-VM
Type: 4 cycle, water-cooled, vertical in-line 6, direct injection, turbo-charger, intercooler
Exhaust level is equivalent with NRMM (Europe) Stage III A and/or US EPA Tier3.
Displacement: 7.684 L
Rated power: 213 kW/2,100 min⁻¹
Max. Torque: 1,017 N·m/1,600 min⁻¹
Cooling System: Water-cooled
Starter: 24V-5kW
Radiator: Corrugated type core, thermostatically controlled
Air cleaner: Dry type with replaceable paper element
Throttle: Twist grip type hand throttle, electrically actuated
Fuel filter: Replaceable paper element
Batteries: Two 12V x 136 Ah/5HR capacity batteries, series connected
Fuel tank capacity: 400 L



Hydraulic System

Main pumps: 3 variable displacement piston pumps
Control: Full-flow hydraulic control system for infinitely variable pressure to all winches, propel and swing. Controls respond instantly to the touch, delivering smooth function operation.
Cooling: Oil-to-air heat exchanger (plate-fin type)
Filtration: Full-flow and bypass type with replaceable element
Max. relief valve pressure:
Load hoist, boom hoist and propel system: 31.9 MPa
Swing system: 27.5 MPa
Control system: 5.4 MPa
Oil Quantity (at the reference level): 380 L



Boom Hoisting System

Powered by a hydraulic motor through a planetary reducer.
Brake: A spring-set, hydraulically released multiple-disc brake is mounted on the boom hoist motor and operated through a counter-balance valve.
Drum Lock: External ratchet for locking drum
Drum: Single drum, grooved for 16 mm dia. wire rope
Line Speed: Single line on first drum layer
Hoisting/Lowering: 70 to 2 m/min
Boom hoisting/lowering: 16 mm x 150 m
Boom guy line: 30 mm
Boom backstops: Required for all boom length



Load Hoisting System

Front and rear drums for load hoist powered by a hydraulic variable plunger motors, driven through planetary reducers.
Negative Brake: A spring-set, hydraulically released multiple-disc brake is mounted on the hoist motor and operated through a counter-balance valve. (Positive free fall brake is optional)
Drum Lock: External ratchet for locking drum
Drums:
Front Drums:
614 mm P.C.D x 617 mm wide drum, grooved for 26 mm wire rope. Rope capacity is 240 m working length and 360 m storage length.
Rear Drum: 614 mm P.C.D x 617 mm, grooved for 26 mm wire rope. Rope capacity is 165 m working length and 360 m storage length.
Diameter of wire rope
Main winch: 26 mm x 240 m
Aux. winch: 26 mm x 165 m
Line Speed*:
Hoisting/lowering: 120 to 3 m/min
Line Pull:
Max. Line Pull*: 208 kN {21.2 ft}
(Referential performance)
Rated Line Pull: 112 kN {11.4 ft}
*Single line on first drum layer



Swing System

Swing unit is powered by hydraulic motor driving spur gears through planetary reducer, the swing system provides 360° rotation.
Swing parking brakes: A spring-set, hydraulically released multiple-disc brake is mounted on swing motor.
Swing circle: Single-row ball bearing with an integral internally cut swing gear.
Swing lock: Manually, four position lock for transportation
Swing Speed: 4.0 min⁻¹



Upper Structure

Torsion-free precision machined upper frame. All components are located clearly and service friendly. Engine will with low noise level.
Counterweight: 31.1 ton



Cab & Control

Totally enclosed from weather, this full-vision cab has safety glass all around. The adjustable, high-backed seat with armrest is capable of adjustment with or without the control console. Auxiliary controls and instruments are on a side mounted console. A signal horn, windshield wipers, air conditioner / heater, storage compartment for manuals, and swing limiter are all standard features.



Lower Structure

Steel-welded carbody with axles. Crawler assemblies can be hydraulically extended for wide-track operation or retracted for transportation. Crawler belt tension is maintained by hydraulic jack force on the track-adjusting bearing block.

Carbodyweight: 15.0 ton

Crawler drive: Independent hydraulic propel drive is built into each crawler side frame. Each drive consists of a hydraulic motor propelling a driving tumbler through a planetary gear box. Hydraulic motor and gear box are built into the crawler side frame within the shoe width.

Crawler brakes: Spring-set, hydraulically released parking brakes are built into each propel drive.

Steering mechanism: A hydraulic propel system provides both skid steering (driving one track only) and counter-rotating steering (driving each track in opposite directions).

Track rollers: Sealed track rollers for maintenance-free operation.

Shoe (flat): 800 mm wide each crawler

Max. gradeability: 40%



Weight

Including upper and lower machine, 31.1 ton counterweight and 15.0 ton carbody weight, basic boom and 100 ton hook.

Weight: 89.9 ton

Ground pressure: 101.3 kPa (14.7 psi)



Attachment

Boom & Jib:

Welded lattice construction using tubular, high-tensile steel chords with pin connection between sections.

Boom and Jib length

	Min. Length (Min. combination)	Max. Length (Max. combination)
Crane Boom	12.2 m	61.0 m
Fixed jib	24.4 m + 9.1 m	51.8 m + 18.3 m

Main Specifications (Model: CKS1000)

Crane Boom	
Max. Lifting Capacity	100 t * x 3.3 m
Max. Length	61.0 m
Fixed Jib	
Max. Lifting Capacity	10.9 t x 18.0 m
Max . Combination	51.8 m + 18.3 m
Main & Aux. Winch	
Max. Line Speed (1st layer)	120 m/min
Rated Line Pull (Single line)	112 kN {11.4 tf}
Wire Rope Diameter	26 mm
Wire Rope Length	240 m (Main), 165 m (Aux)
Brake Type (free fall)	Wet-type multiple disc brake (Optional)
Working Speed	
Swing Speed	4.0 min ⁻¹ {rpm}
Travel Speed	1.7/1.1 km/h
Power Plant	
Model	HINO J08E-VM
Engine Output	213 kW/2100 min ⁻¹
Fuel Tank	400 L

Hydraulic System	
Main Pumps	3 variable displacement
Max. Pressure	31.9 MPa {325 kgf/cm ² }
Oil Quantity (at the reference level)	380 L
Self-Removal Device	
	Counterweight/self-removal device (Option)
Weight	
Operating Weight	89.9 t * ¹
Ground Pressure	101.3 kPa (14.7 psi)
Counterweight	31,100 kg
Transport Weight	40,415 kg * ²

Units are SI units. { } indicates conventional units.

Line speeds in table are for light loads. Line speed varies with load.

*¹ Including upper and lower machine, 31.1 ton counterweight, 15.0 ton carbody weight, basic boom, hook, and other accessories.

*² Base machine with boom base, gantry, crawlers, and wire ropes (front/boom hoist)

* The value are theoretical result.

GENERAL DIMENSIONS

(Unit: mm)

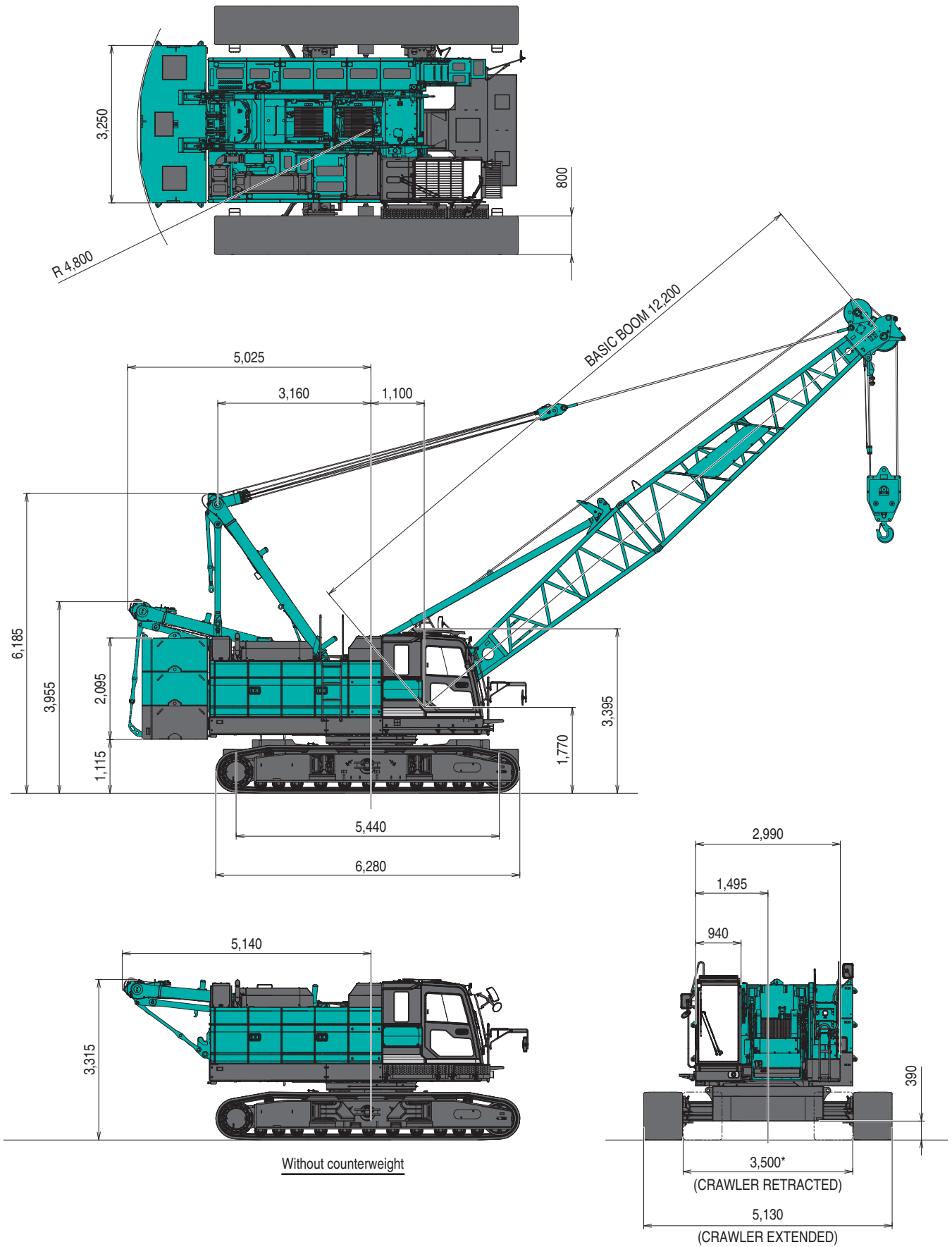

Without counterweight

This catalog may contain photographs of machines with specifications, attachments and optional equipment.

*With narrow gauge carbody weight or without weight

BOOM AND JIB ARRANGEMENTS

Limit of Hook Lifting

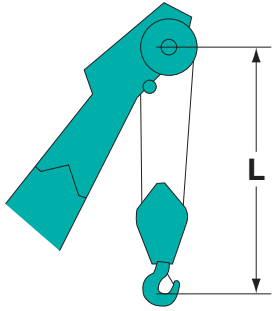

Hook	L
100 t hook	4.1 m
70 t hook	4.1 m
50 t hook	4.0 m
35 t hook	3.9 m

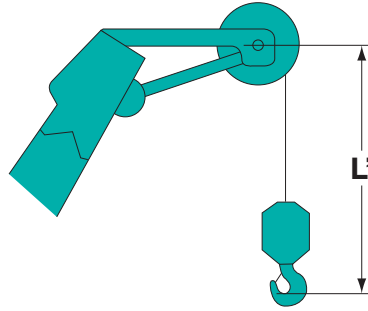

Hook	L'
Ball hook	3.5 m

Crane Boom Arrangements

Boom length m (ft)	Boom arrangement
12.2 (40)	
15.2 (50)	
18.3 (60)	※
21.3 (70)	※
24.4 (80)	※
27.4 (90)	※
30.5 (100)	※
33.5 (110)	※
36.6 (120)	※
39.6 (130)	※
42.7 (140)	※

Boom length m (ft)	Boom arrangement
45.7 (150)	※
48.8 (160)	※
51.8 (170)	※
54.9 (180)	※
57.9 (190)	※
61.0 (200)	※

Symbol	Boom Length	Remarks
	5.8 m	Boom Base
	6.4 m	Boom Tip
	3.0 m	Boom Insert
	6.1 m	Boom Insert
	12.2 m	Boom Insert
	12.2 m	Boom Insert with lug

△ Mark shows the boom insert with lugs attached

△ Mark shows the boom insert with lugs attached and the guy line installing position when the fixed jib is used.

※ Mark shows the standard boom arrangement which make the boom arrangement of less than the each boom length possible.

○ Mark shows the installing of the cable roller for the boom insert.

Fixed Jib Arrangements

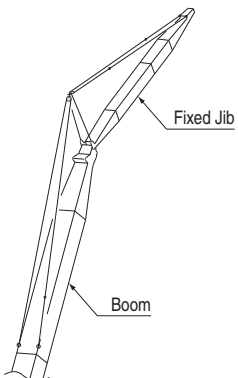

Crane boom length	Jib length m (ft)	Jib arrangement
24.4 m to 51.8 m	9.1 (30)	
	12.2 (40)	
	15.2 (50)	
	18.3 (60)	

Symbol	Jib Length	Remarks
	4.6 m	Jib Base
	4.6 m	Jib Tip
	3.0 m	Jib Insert
	6.1 m	Jib Insert

WORKING RANGES

Crane Boom

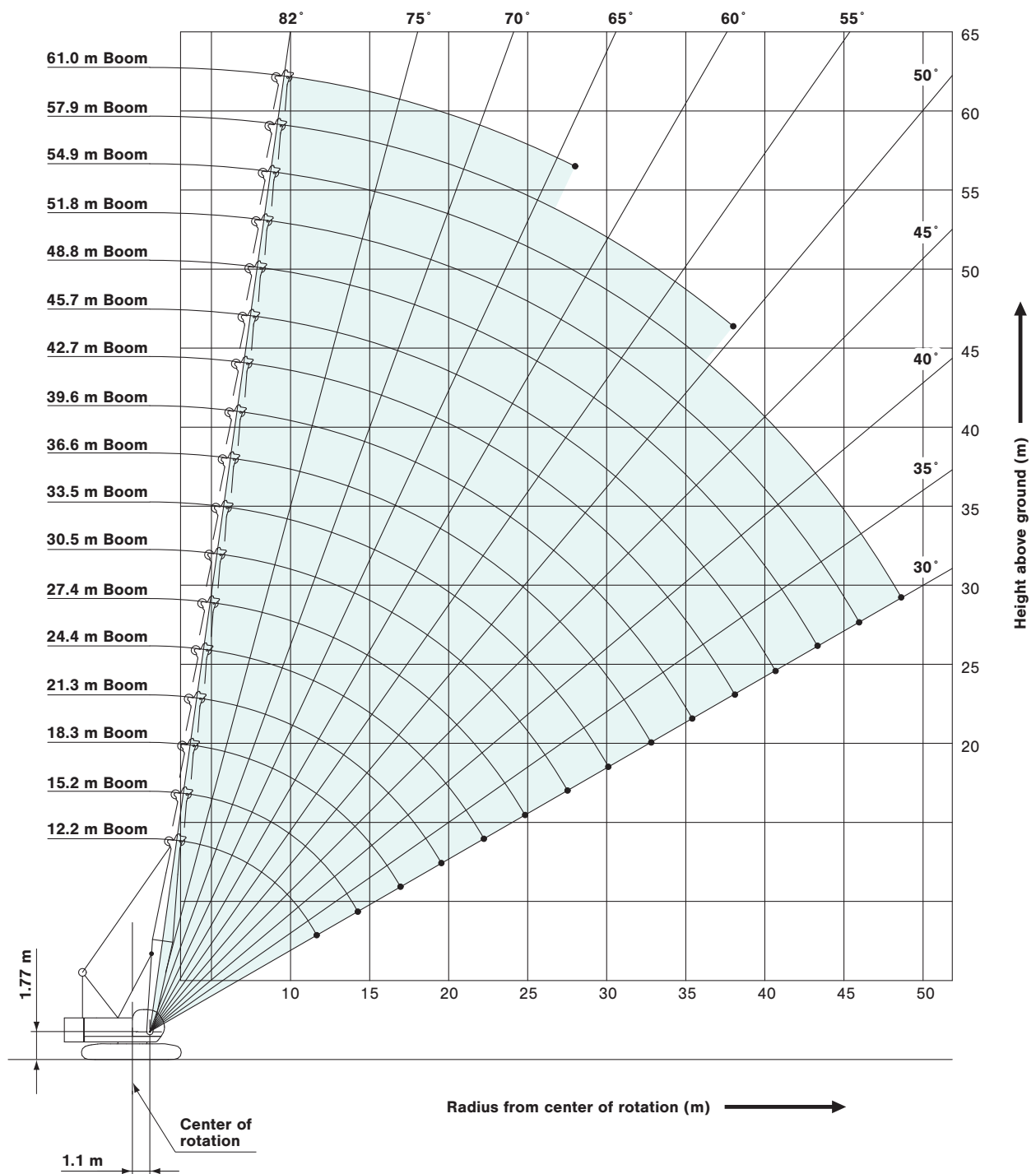

Fixed Jib 10°

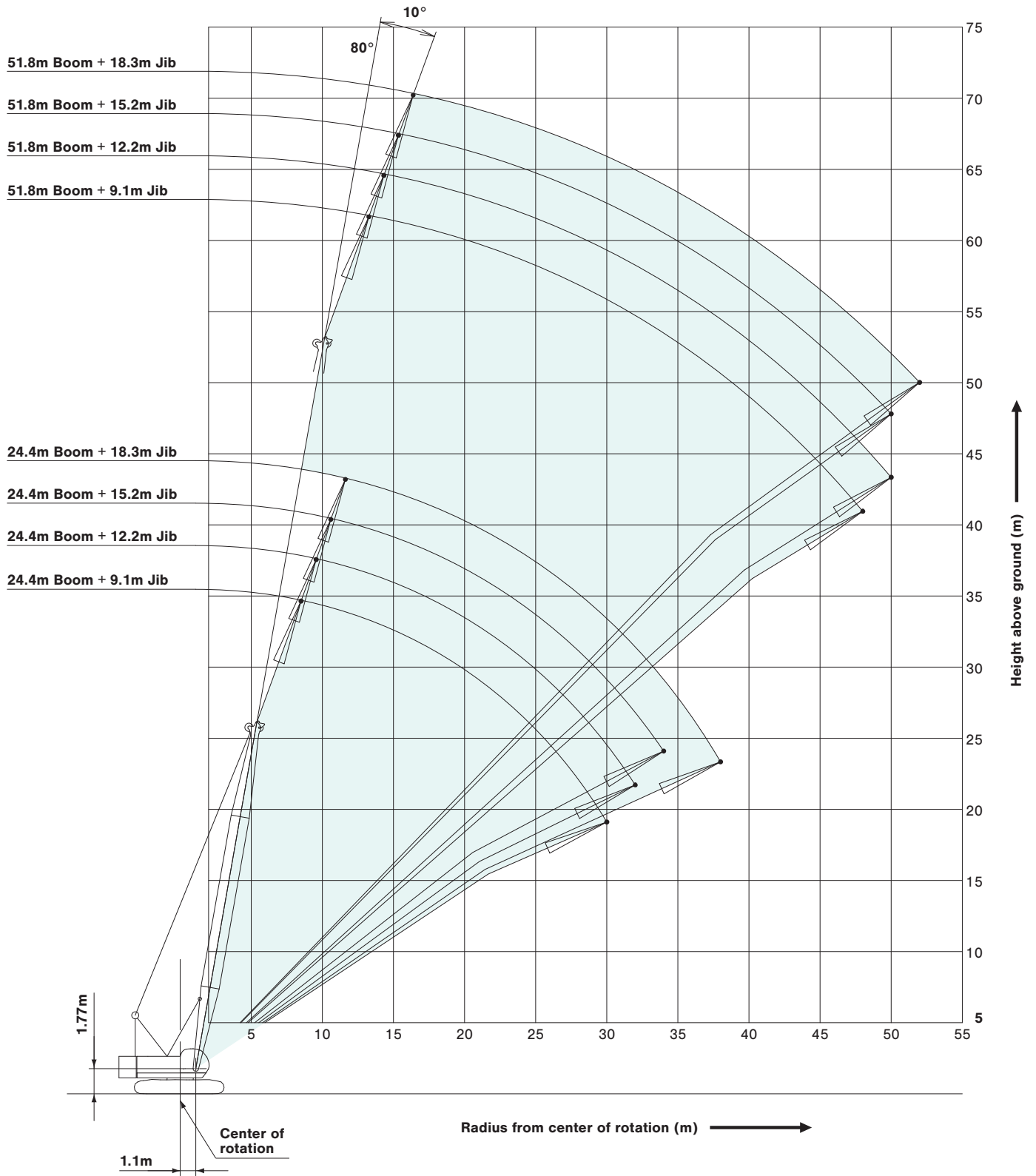

WORKING RANGES

Fixed Jib 30°

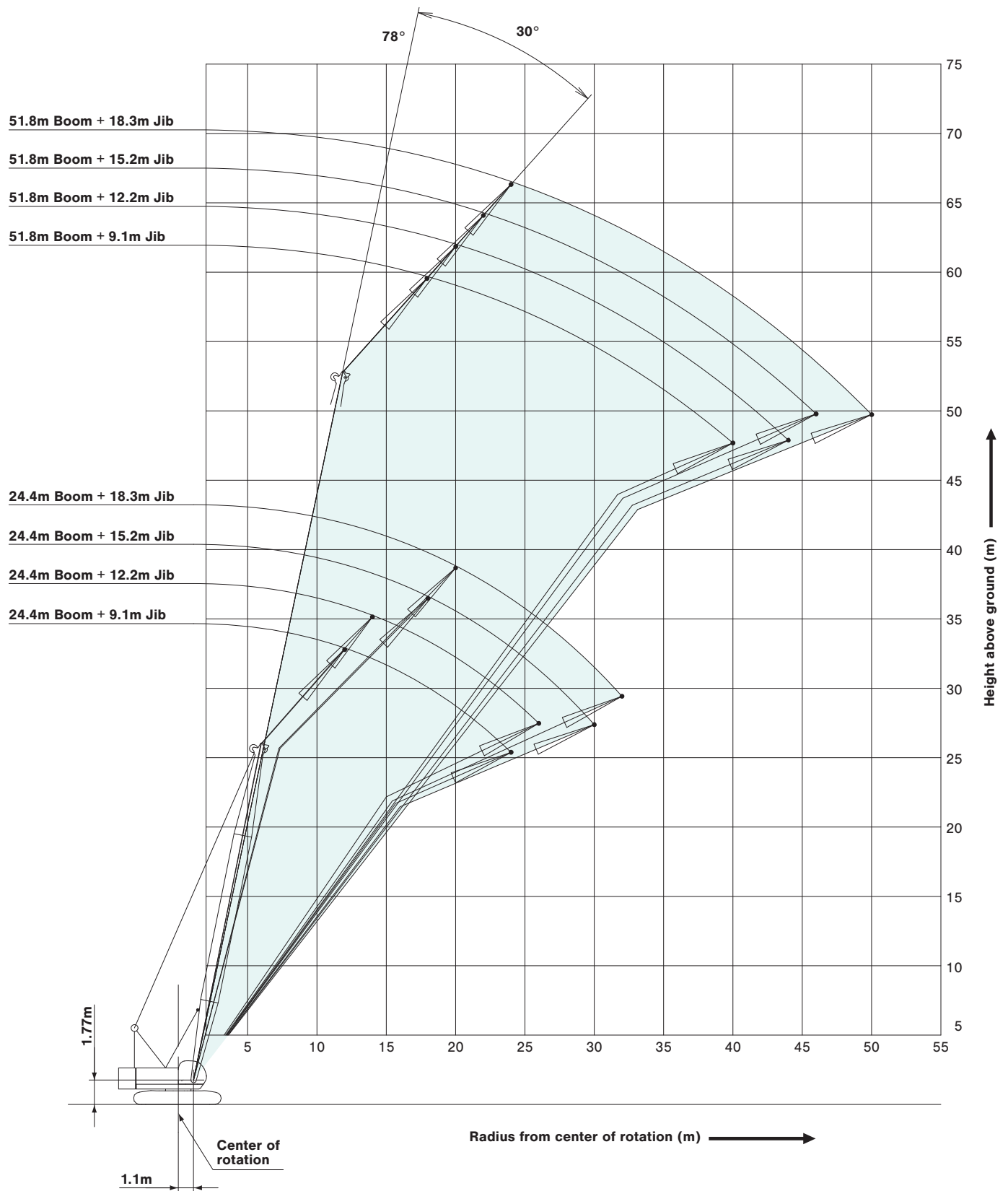

SUPPLEMENTAL DATA

- Ratings are calculated to comply with EN13000, ISO4305 and include factors based on a 4 degree tipping angle.
- Operating radius is the horizontal distance from centerline of rotation to a vertical line through the center of gravity of the load.
- Deduct weight of hook block(s), slings and all other load handling accessories from main boom ratings shown.
- Ratings shown are based on freely suspended loads and make no allowance for such factors as wind effect on lifted load, ground conditions, out-of-level, operating speeds or any other condition that could be detrimental to the safe operation of this equipment. The operator, therefore, has the responsibility to judge the existing conditions and reduce lifted loads and operating speeds accordingly.
- Ratings are for operation on a firm and level surface, up to 1% gradient.
- At radii and boom lengths where no ratings are shown on chart, operation is not intended nor approved.
- Boom inserts and guy lines must be arranged as shown in the "operator's manual".
- Boom hoist reeving is 12 part line.
- Gantry must be in raised position for all conditions.
- Boom backstops are required for all boom lengths.
- The boom should be erected over the front of the crawlers, not laterally.
- Ratings inside of boxes are limited by strength of materials.
- The minimum rated load is 1.4(ton).
- Crawler frames must be fully extended for all crane operations.

(MAIN BOOM)

- The total load that can be lifted is the value for weight of hook block, slings, and all other load handling accessories deducted from main boom ratings shown.

(MAIN BOOM WITH AUXILIARY SHEAVE FRAME)

- The total load that can be lifted is the value for weight of main hook block, slings, and all other load handling accessories deducted from main boom with auxiliary sheave ratings shown.

(AUXILIARY SHEAVE)

- The total load that can be lifted is the value for weight of auxiliary sheave hook block, slings, and all other load handling accessories deducted from auxiliary sheave ratings shown.
- Boom lengths for auxiliary sheave mounting are 12.2m to 57.9m.

(MAIN BOOM WITH FIXED JIB)

- The total load that can be lifted is the value for weight of main hook block, slings, and all other load handling accessories deducted from main boom with fixed jib ratings shown.
- Only 35t, 50t and 70t hook block can be used for main hook.

(FIXED JIB)

- The total load that can be lifted is the value for weight of jib hook block, slings, and all other load handling accessories deducted from fixed jib ratings shown.
- Boom lengths for fixed jib mounting are 24.4m to 51.8m.

<Reference Information>

Main hoist loads

No. of Parts of Line	1	2	3	4	5
Maximum Loads (kN)	112	224	335	447	559
Maximum Loads (t)	11.4	22.8	34.2	45.6	57.0

No. of Parts of Line	6	7*	8*
Maximum Loads (kN)	671	779	883
Maximum Loads (t)	68.4	79.4	90.0

* : Use auxiliary sheave

Auxiliary hoist loads

No. of Parts of Line	1
Maximum Loads (kN)	108
Maximum Loads (t)	11.0

Weight of hook block					
Hook Block	100 t	70 t	50 t	35 t	11 t Ball Hook
Weight (t)	1.3	0.9	0.85	0.7	0.3

- Lifting capacities listed apply only to the machine as originally manufactured and designed by KOBELCO CONSTRUCTION MACHINERY CO.,LTD. modifications to this machine or use of equipment other than that specified can reduce operating capacity.

Operation of this equipment in excess of rated loads or disregard of instruction voids the warranty.

Assembling the counterweight

31.1 ton counterweight
15.0 ton carbody weight
(Standard type)

No.3	(10 t)
No.2	(10 t)
No.1	(11 t)

Counterweights

(7.5 t × 2 pieces)

Carbody weights

LIFTING CAPACITIES



Crane Boom Lifting Capacity

Counterweight: 31.1 t
Carbody Weight: 15.0 t

Unit: metric ton

Working radius (m)	Boom length (m)											Working radius (m)
	12.2	15.2	18.3	21.3	24.4	27.4	30.5	33.5	36.6	39.6		
3.3	100.0*											3.3
3.9	90.0	89.9	89.7									3.9
4.0	89.0	88.9	88.7	4.3m/68.4								4.0
4.5	79.6	79.5	79.4	68.4	4.7m/68.4							4.5
5.0	72.1	71.9	71.8	68.4	67.6	5.1m/57.0						5.0
5.5	65.8	65.7	65.5	63.6	60.6	57.0	5.6m/54.0					5.5
6.0	60.5	60.3	59.9	57.5	54.9	52.7	50.5	45.6	6.4m/41.9	6.8m/34.2		6.0
7.0	48.6	48.5	48.4	48.1	46.2	44.5	42.9	41.5	40.0	34.2		7.0
8.0	39.9	39.8	39.7	39.9	39.8	38.5	37.2	36.1	35.0	33.9		8.0
9.0	33.8	33.7	33.6	33.8	33.6	33.6	32.8	31.9	31.0	30.1		9.0
10.0	29.3	29.2	29.1	29.2	29.1	29.0	28.9	28.5	27.7	27.0		10.0
12.0	11.8m/22.9	22.9	22.8	22.9	22.8	22.7	22.6	22.6	22.5	22.3		12.0
14.0		18.8	18.6	18.8	18.6	18.5	18.4	18.4	18.3	18.3		14.0
16.0		14.4m/18.1	15.7	15.8	15.7	15.6	15.5	15.4	15.3	15.3		16.0
18.0			17.0m/14.5	13.7	13.5	13.4	13.3	13.2	13.1	13.1		18.0
20.0				19.6m/12.2	11.8	11.7	11.6	11.5	11.4	11.4		20.0
22.0					10.5	10.4	10.2	10.2	10.0	10.0		22.0
24.0					22.3m/10.3	9.3	9.1	9.1	8.9	8.9		24.0
26.0						24.9m/8.8	8.2	8.2	8.0	8.0		26.0
28.0							27.6m/7.6	7.4	7.2	7.2		28.0
30.0								6.8	6.6	6.5		30.0
32.0								30.2m/6.7	6.0	6.0		32.0
34.0									32.9m/5.8	5.5		34.0
36.0										35.5m/5.1		36.0
Reeves	8	8	8	6	6	5	5	4	4	3		Reeves

Working radius (m)	Boom length (m)							Working radius (m)
	42.7	45.7	48.8	51.8	54.9	57.9	61.0	
7.0	7.3m/31.9	7.7m/28.0						7.0
8.0	31.4	27.8	8.1m/22.1	8.5m/19.2				8.0
9.0	29.2	26.2	20.8	18.6	16.2	9.4m/13.9	9.8m/11.8	9.0
10.0	26.2	24.5	19.5	17.4	15.2	13.4	11.7	10.0
12.0	21.7	21.2	17.3	15.4	13.3	11.7	10.2	12.0
14.0	18.1	18.0	15.5	13.8	11.9	10.4	9.0	14.0
16.0	15.2	15.1	14.1	12.4	10.7	9.3	8.0	16.0
18.0	12.9	12.9	12.8	11.4	9.7	8.4	7.2	18.0
20.0	11.2	11.2	11.1	10.4	8.9	7.6	6.5	20.0
22.0	9.9	9.8	9.8	9.6	8.1	7.0	5.9	22.0
24.0	8.7	8.7	8.6	8.5	7.5	6.4	5.4	24.0
26.0	7.8	7.7	7.7	7.6	6.9	5.9	4.9	26.0
28.0	7.0	7.0	6.9	6.8	6.4	5.4	4.5	28.0
30.0	6.4	6.3	6.3	6.1	6.0	5.0	4.1	30.0
32.0	5.8	5.7	5.7	5.6	5.4	4.6	3.8	32.0
34.0	5.3	5.2	5.1	5.0	4.9	4.3	3.4	34.0
36.0	4.8	4.8	4.7	4.6	4.4	4.0	3.2	36.0
38.0	4.4	4.4	4.2	4.1	4.0	3.6	2.9	38.0
40.0	38.1m/4.4	4.0	3.9	3.8	3.6	3.3	2.6	40.0
44.0		40.8m/3.9	43.4m/3.3	3.1	3.0	2.8	2.1	44.0
48.0				46.1m/2.8	2.5	2.2	1.7	48.0
52.0					48.7m/2.4	51.4m/1.8		52.0
Reeves	3	3	2	2	2	2	2	Reeves

Note:

Ratings according to EN13000.

Ratings shown in are determined by the strength of the boom or other structural components.

The rated capacity at 3.3 m working radius is only the condition at the basic boom with 8 parts of line on the hook block.

Lifting capacities may vary depending on hook used or with/without auxiliary sheave.

Please refer rated chart in operator's cabin.



Aux. Sheave Lifting Capacity (1 Part of Line / Without Main Hook Block)

Counterweight: 31.1 t
Carbody Weight: 15.0 t

Unit: metric ton

Working radius (m)	Boom length (m)											Working radius (m)
	12.2	15.2	18.3	21.3	24.4	27.4	30.5	33.5	36.6	39.6		
5.0	11.0	11.0	11.0	11.0	11.0							5.0
5.5	11.0	11.0	11.0	11.0	11.0							5.5
6.0	11.0	11.0	11.0	11.0	11.0	11.0	11.0					6.0
7.0	11.0	11.0	11.0	11.0	11.0	11.0	11.0	11.0	11.0	11.0		7.0
8.0	11.0	11.0	11.0	11.0	11.0	11.0	11.0	11.0	11.0	11.0	11.0	8.0
9.0	11.0	11.0	11.0	11.0	11.0	11.0	11.0	11.0	11.0	11.0	11.0	9.0
10.0	11.0	11.0	11.0	11.0	11.0	11.0	11.0	11.0	11.0	11.0	11.0	10.0
12.0	11.8m/11.0	11.0	11.0	11.0	11.0	11.0	11.0	11.0	11.0	11.0	11.0	12.0
14.0		11.0	11.0	11.0	11.0	11.0	11.0	11.0	11.0	11.0	11.0	14.0
16.0		14.4m/11.0	11.0	11.0	11.0	11.0	11.0	11.0	11.0	11.0	11.0	16.0
18.0			17.0m/11.0	11.0	11.0	11.0	11.0	11.0	11.0	11.0	11.0	18.0
20.0				19.6m/11.0	11.0	11.0	11.0	11.0	11.0	11.0	11.0	20.0
22.0					10.3	10.2	10.0	10.0	9.8	9.8		22.0
24.0					22.3m/10.1	9.1	8.9	8.9	8.7	8.7		24.0
26.0						24.9m/8.6	8.0	8.0	7.8	7.8		26.0
28.0							27.6m/7.4	7.2	7.0	7.0		28.0
30.0								6.6	6.4	6.3		30.0
32.0								30.2m/6.5	5.8	5.8		32.0
34.0									32.9m/5.6	5.3		34.0
36.0										35.5m/4.9		36.0
Reeves	1	1	1	1	1	1	1	1	1	1	1	Reeves

Working radius (m)	Boom length (m)						Working radius (m)
	42.7	45.7	48.8	51.8	54.9	57.9	
8.0	11.0	11.0					8.0
9.0	11.0	11.0	11.0	11.0			9.0
10.0	11.0	11.0	11.0	11.0	11.0	11.0	10.0
12.0	11.0	11.0	11.0	11.0	11.0	11.0	12.0
14.0	11.0	11.0	11.0	11.0	11.0	10.2	14.0
16.0	11.0	11.0	11.0	11.0	10.5	9.1	16.0
18.0	11.0	11.0	11.0	11.0	9.5	8.2	18.0
20.0	11.0	11.0	10.9	10.2	8.7	7.4	20.0
22.0	9.7	9.6	9.6	9.4	7.9	6.8	22.0
24.0	8.5	8.5	8.4	8.3	7.3	6.2	24.0
26.0	7.6	7.5	7.5	7.4	6.7	5.7	26.0
28.0	6.8	6.8	6.7	6.6	6.2	5.2	28.0
30.0	6.2	6.1	6.1	5.9	5.8	4.8	30.0
32.0	5.6	5.5	5.5	5.4	5.2	4.4	32.0
34.0	5.1	5.0	4.9	4.8	4.7	4.1	34.0
36.0	4.6	4.6	4.5	4.4	4.2	3.8	36.0
38.0	4.2	4.2	4.0	3.9	3.8	3.4	38.0
40.0	38.1m/4.2	3.8	3.7	3.6	3.4	3.1	40.0
44.0		40.8m/3.7	43.4m/3.1	2.9	2.8	2.6	44.0
48.0				46.1m/2.6	2.3	2.0	48.0
52.0					48.7m/2.2	51.4m/1.6	52.0
Reeves	1	1	1	1	1	1	Reeves

Note:

Ratings according to EN13000.

Ratings shown in are determined by the strength of the boom or other structural components.

Lifting capacities may vary depending on hook used or with/without auxiliary sheave.

Please refer rated chart in operator's cabin.

LIFTING CAPACITIES



2 Part-line Aux. Sheave Lifting Capacity (Optional) (Without Main Hook Block)

Counterweight: 31.1 t
Carbody Weight: 15.0 t

Unit: metric ton

Working radius (m)	Boom length (m)											Boom length (m)	Working radius (m)
		12.2	15.2	18.3	21.3	24.4	27.4	30.5	33.5	36.6	39.6		
5.0		22.0	22.0	22.0	22.0	22.0							5.0
5.5		22.0	22.0	22.0	22.0	22.0							5.5
6.0		22.0	22.0	22.0	22.0	22.0	22.0	22.0					6.0
7.0		22.0	22.0	22.0	22.0	22.0	22.0	22.0	22.0	22.0	22.0		7.0
8.0		22.0	22.0	22.0	22.0	22.0	22.0	22.0	22.0	22.0	22.0		8.0
9.0		22.0	22.0	22.0	22.0	22.0	22.0	22.0	22.0	22.0	22.0		9.0
10.0		22.0	22.0	22.0	22.0	22.0	22.0	22.0	22.0	22.0	22.0		10.0
12.0		11.8m/22.0	22.0	22.0	22.0	22.0	22.0	21.9	21.9	21.8	21.6		12.0
14.0			18.1	17.9	18.1	17.9	17.8	17.7	17.7	17.6	17.6		14.0
16.0			14.4m/17.4	15.0	15.1	15.0	14.9	14.8	14.7	14.6	14.6		16.0
18.0				17.0m/13.8	13.0	12.8	12.7	12.6	12.5	12.4	12.4		18.0
20.0					19.6m/11.5	11.1	11.0	10.9	10.8	10.7	10.7		20.0
22.0						9.8	9.7	9.5	9.5	9.3	9.3		22.0
24.0						22.3m/9.6	8.6	8.4	8.4	8.2	8.2		24.0
26.0							24.9m/8.1	7.5	7.5	7.3	7.3		26.0
28.0								27.6m/6.9	6.7	6.5	6.5		28.0
30.0									6.1	5.9	5.8		30.0
32.0									30.2m/6.0	5.3	5.3		32.0
34.0										32.9m/5.1	4.8		34.0
36.0											35.5m/4.4		36.0
Reeves		2	2	2	2	2	2	2	2	2	2		Reeves

Working radius (m)	Boom length (m)							Boom length (m)	Working radius (m)
		42.7	45.7	48.8	51.8	54.9	57.9		
8.0		22.0	22.0						8.0
9.0		22.0	22.0	20.1	17.9				9.0
10.0		22.0	22.0	18.8	16.7	14.5	12.7		10.0
12.0		21.0	20.5	16.6	14.7	12.6	11.0		12.0
14.0		17.4	17.3	14.8	13.1	11.2	9.7		14.0
16.0		14.5	14.4	13.4	11.7	10.0	8.6		16.0
18.0		12.2	12.2	12.1	10.7	9.0	7.7		18.0
20.0		10.5	10.5	10.4	9.7	8.2	6.9		20.0
22.0		9.2	9.1	9.1	8.9	7.4	6.3		22.0
24.0		8.0	8.0	7.9	7.8	6.8	5.7		24.0
26.0		7.1	7.0	7.0	6.9	6.2	5.2		26.0
28.0		6.3	6.3	6.2	6.1	5.7	4.7		28.0
30.0		5.7	5.6	5.6	5.4	5.3	4.3		30.0
32.0		5.1	5.0	5.0	4.9	4.7	3.9		32.0
34.0		4.6	4.5	4.4	4.3	4.2	3.6		34.0
36.0		4.1	4.1	4.0	3.9	3.7	3.3		36.0
38.0		3.7	3.7	3.5	3.4	3.3	2.9		38.0
40.0		38.1m/3.7	3.3	3.2	3.1	2.9	2.6		40.0
44.0			40.8m/3.2	43.4m/2.6	2.4	2.3	2.1		44.0
48.0					46.1m/2.1	1.8	1.5		48.0
52.0						48.7m/1.7			52.0
Reeves		2	2	2	2	2	2		Reeves

Note:

Ratings according to EN13000.

Ratings shown in are determined by the strength of the boom or other structural components.

Lifting capacities may vary depending on hook used or with/without auxiliary sheave.

Please refer rated chart in operator's cabin.



Fixed Jib Lifting Capacity (Without Main Hook Block) (Jib Offset Angle : 10°)

Counterweight: 31.1 t
Carbody Weight: 15.0 t

Unit: metric ton

Boom length (m)		24.4				27.4				30.5				Boom length (m)	
Jib length (m)		9.1	12.2	15.2	18.3	9.1	12.2	15.2	18.3	9.1	12.2	15.2	18.3	Jib length (m)	
Working radius (m)	9.0	10.9													9.0
	10.0	10.9				10.9				10.9					10.0
	12.0	10.9	10.9	9.0		10.9	10.9	9.0		10.9	10.9				12.0
	14.0	10.9	10.9	9.0	8.1	10.9	10.9	9.0	8.1	10.9	10.9	9.0	8.1		14.0
	16.0	10.9	10.5	8.7	7.7	10.9	10.9	9.0	7.9	10.9	10.9	9.0	8.1		16.0
	18.0	10.9	9.5	7.8	6.8	10.9	10.2	8.3	7.2	10.9	10.6	8.7	7.5		18.0
	20.0	10.3	8.6	7.1	6.2	10.2	9.2	7.5	6.5	10.1	9.7	7.9	6.8		20.0
	22.0	9.0	7.8	6.5	5.6	8.9	8.4	6.9	5.9	8.8	8.9	7.2	6.2		22.0
	24.0	8.0	7.2	5.9	5.1	7.9	7.7	6.3	5.4	7.8	8.0	6.6	5.7		24.0
	26.0	7.2	6.7	5.5	4.7	7.1	7.1	5.8	5.0	7.0	7.1	6.2	5.3		26.0
	28.0	6.5	6.2	5.1	4.4	6.4	6.5	5.4	4.6	6.3	6.4	5.7	4.9		28.0
	30.0	5.9	5.8	4.8	4.1	5.8	5.9	5.1	4.3	5.7	5.8	5.4	4.6		30.0
	32.0		5.5	4.5	3.8	5.3	5.4	4.8	4.1	5.2	5.3	5.1	4.3		32.0
	34.0			4.2	3.6		4.9	4.5	3.8	4.7	4.8	4.8	4.0		34.0
	36.0				3.4			4.3	3.6		4.4	4.5	3.8		36.0
	38.0				3.2			4.1	3.4		4.0	4.1	3.6		38.0
	40.0								3.2			3.8	3.4		40.0
42.0												3.3		42.0	
44.0												3.1		44.0	
Reeves	1	1	1	1	1	1	1	1	1	1	1	1	1	Reeves	

Boom length (m)		33.5				36.6				39.6				Boom length (m)	
Jib length (m)		9.1	12.2	15.2	18.3	9.1	12.2	15.2	18.3	9.1	12.2	15.2	18.3	Jib length (m)	
Working radius (m)	12.0	10.9	10.9			10.9				10.9					12.0
	14.0	10.9	10.9	9.0	8.1	10.9	10.9	9.0		10.9	10.9	9.0			14.0
	16.0	10.9	10.9	9.0	8.1	10.9	10.9	9.0	8.1	10.9	10.9	9.0	8.1		16.0
	18.0	10.9	10.9	9.0	7.8	10.9	10.9	9.0	8.1	10.9	10.9	9.0	8.1		18.0
	20.0	10.0	10.1	8.3	7.1	9.9	10.0	8.6	7.4	9.8	9.9	9.0	7.7		20.0
	22.0	8.7	8.8	7.6	6.5	8.6	8.7	8.0	6.8	8.5	8.6	8.2	7.0		22.0
	24.0	7.8	7.8	7.0	6.0	7.5	7.7	7.3	6.2	7.4	7.6	7.7	6.5		24.0
	26.0	7.0	7.0	6.5	5.5	6.7	6.9	6.8	5.8	6.6	6.8	6.9	6.0		26.0
	28.0	6.2	6.3	6.0	5.1	6.1	6.2	6.2	5.4	6.0	6.1	6.1	5.6		28.0
	30.0	5.6	5.7	5.6	4.8	5.5	5.5	5.7	5.0	5.4	5.4	5.6	5.2		30.0
	32.0	5.1	5.2	5.2	4.5	5.0	5.0	5.1	4.7	4.8	4.9	5.0	4.9		32.0
	34.0	4.7	4.7	4.8	4.2	4.5	4.6	4.7	4.4	4.4	4.5	4.5	4.6		34.0
	36.0	4.2	4.3	4.4	4.0	4.1	4.2	4.2	4.2	4.0	4.1	4.1	4.2		36.0
	38.0	3.9	4.0	4.0	3.8	3.8	3.8	3.9	3.9	3.7	3.7	3.8	3.8		38.0
	40.0		3.7	3.7	3.6	3.4	3.5	3.6	3.6	3.3	3.4	3.4	3.5		40.0
	42.0			3.4	3.4		3.2	3.3	3.3	3.0	3.1	3.2	3.2		42.0
	44.0				3.2			3.0	3.1		2.7	2.9	2.9		44.0
46.0								2.8			2.6	2.7		46.0	
48.0								2.4			2.2	2.4		48.0	
50.0												2.1		50.0	
Reeves	1	1	1	1	1	1	1	1	1	1	1	1	1	Reeves	

Note:

Ratings according to EN13000.

Ratings shown in are determined by the strength of the boom or other structural components.

Lifting capacities may vary depending on hook used or with/without auxiliary sheave.

Please refer rated chart in operator's cabin.

LIFTING CAPACITIES



Fixed Jib Lifting Capacity (Without Main Hook Block) (Jib Offset Angle : 10°)

Counterweight: 31.1 t
Carbody Weight: 15.0 t

Unit: metric ton

Boom length (m)		42.7				45.7				48.8				Boom length (m)	
Jib length (m)		9.1	12.2	15.2	18.3	9.1	12.2	15.2	18.3	9.1	12.2	15.2	18.3	Jib length (m)	
Working radius (m)	14.0	10.9	10.9			10.9	10.9			10.9				14.0	Working radius (m)
	16.0	10.9	10.9	9.0		10.9	10.9	9.0		10.9	10.9			16.0	
	18.0	10.9	10.9	9.0	8.1	10.8	10.9	9.0	8.1	10.8	10.9	9.0	8.1	18.0	
	20.0	9.6	9.8	9.0	7.9	9.5	9.6	9.0	8.1	9.5	9.6	9.0	8.1	20.0	
	22.0	8.4	8.5	8.5	7.3	8.3	8.4	8.5	7.6	8.2	8.4	8.5	7.8	22.0	
	24.0	7.3	7.5	7.6	6.7	7.2	7.4	7.5	7.0	7.2	7.3	7.4	7.2	24.0	
	26.0	6.5	6.7	6.7	6.3	6.4	6.5	6.7	6.5	6.3	6.5	6.6	6.7	26.0	
	28.0	5.8	5.9	6.0	5.8	5.7	5.8	5.9	6.0	5.7	5.8	5.9	5.9	28.0	
	30.0	5.2	5.3	5.4	5.4	5.1	5.2	5.3	5.4	5.1	5.2	5.2	5.3	30.0	
	32.0	4.7	4.8	4.9	4.9	4.6	4.7	4.8	4.8	4.6	4.6	4.7	4.8	32.0	
	34.0	4.3	4.3	4.4	4.5	4.2	4.2	4.3	4.4	4.1	4.2	4.3	4.3	34.0	
	36.0	3.8	3.9	4.0	4.0	3.7	3.8	3.9	3.9	3.7	3.8	3.8	3.9	36.0	
	38.0	3.5	3.6	3.6	3.7	3.5	3.5	3.5	3.6	3.4	3.4	3.5	3.5	38.0	
	40.0	3.2	3.3	3.3	3.3	3.1	3.2	3.2	3.3	3.0	3.1	3.2	3.2	40.0	
	42.0	2.9	3.0	3.0	3.1	2.8	2.9	2.9	3.0	2.8	2.8	2.9	2.9	42.0	
	44.0	2.5	2.7	2.8	2.8	2.5	2.6	2.7	2.7	2.5	2.5	2.6	2.6	44.0	
	46.0	2.2	2.3	2.5	2.6	2.2	2.3	2.4	2.5	2.2	2.2	2.4	2.4	46.0	
48.0		2.0	2.2	2.3	1.8	2.0	2.1	2.2	1.8	1.9	2.1	2.1	48.0		
50.0			1.9	2.0		1.7	1.8	1.9	1.4	1.6	1.8	1.9	50.0		
52.0				1.7			1.6	1.7			1.5	1.6	52.0		
Reeves		1	1	1	1	1	1	1	1	1	1	1	1	Reeves	

Boom length (m)		51.8			
Jib length (m)		9.1	12.2	15.2	18.3
Working radius (m)	14.0	10.9			
	16.0	10.9	10.9		
	18.0	10.7	10.8	9.0	8.1
	20.0	9.4	9.5	9.0	8.1
	22.0	8.1	8.3	8.3	8.0
	24.0	7.1	7.2	7.3	7.4
	26.0	6.2	6.4	6.5	6.6
	28.0	5.6	5.7	5.8	5.8
	30.0	5.0	5.1	5.1	5.2
	32.0	4.4	4.5	4.6	4.7
	34.0	4.0	4.1	4.2	4.2
	36.0	3.6	3.6	3.7	3.8
	38.0	3.3	3.3	3.4	3.4
	40.0	2.9	3.0	3.0	3.1
42.0	2.7	2.7	2.8	2.8	
44.0	2.3	2.4	2.5	2.5	
46.0	2.1	2.1	2.2	2.3	
48.0	1.7	1.8	1.9	2.0	
50.0		1.5	1.6	1.7	
52.0				1.5	
Reeves		1	1	1	1

Note:

Ratings according to EN13000.

Ratings shown in are determined by the strength of the boom or other structural components.

Lifting capacities may vary depending on hook used or with/without auxiliary sheave.

Please refer rated chart in operator's cabin.



Fixed Jib Lifting Capacity (Without Main Hook Block) (Jib Offset Angle : 30°)

Counterweight: 31.1 t
Carbody Weight: 15.0 t

Unit: metric ton

Boom length (m)		24.4				27.4				30.5				Boom length (m)	
Jib length (m)		9.1	12.2	15.2	18.3	9.1	12.2	15.2	18.3	9.1	12.2	15.2	18.3	Jib length (m)	
Working radius (m)	12.0	9.5													12.0
	14.0	9.3	6.9			9.4				9.5					14.0
	16.0	8.6	6.4			8.9	6.5			9.0	6.7				16.0
	18.0	8.0	5.9	4.8		8.3	6.1	4.9		8.6	6.2	5.0			18.0
	20.0	7.5	5.6	4.5	3.8	7.8	5.7	4.6	3.9	8.0	5.9	4.7	3.9		20.0
	22.0	7.1	5.3	4.2	3.6	7.4	5.4	4.3	3.6	7.6	5.6	4.4	3.7		22.0
	24.0	6.8	5.0	4.0	3.4	7.0	5.1	4.1	3.4	7.3	5.3	4.2	3.5		24.0
	26.0		4.8	3.8	3.2		4.9	3.9	3.2	7.0	5.1	4.0	3.3		26.0
	28.0			3.6	3.0		4.7	3.7	3.0	6.4	4.9	3.8	3.1		28.0
	30.0			3.5	2.9			3.6	2.9		4.7	3.7	3.0		30.0
	32.0				2.8			3.5	2.8			3.6	2.9		32.0
	34.0								2.7				2.8		34.0
	36.0												2.7		36.0
Reeves		1	1	1	1	1	1	1	1	1	1	1	1	Reeves	

Boom length (m)		33.5				36.6				39.6				Boom length (m)	
Jib length (m)		9.1	12.2	15.2	18.3	9.1	12.2	15.2	18.3	9.1	12.2	15.2	18.3	Jib length (m)	
Working radius (m)	14.0	9.5				9.5									14.0
	16.0	9.3	6.8			9.4				9.5					16.0
	18.0	8.8	6.4			9.0	6.5			9.2	6.6				18.0
	20.0	8.3	6.1	4.8	4.0	8.5	6.2	4.9	4.1	8.8	6.3	4.9			20.0
	22.0	7.9	5.7	4.5	3.8	8.1	5.9	4.6	3.9	8.3	6.0	4.7	3.9		22.0
	24.0	7.5	5.5	4.3	3.6	7.7	5.6	4.4	3.7	7.7	5.7	4.5	3.7		24.0
	26.0	7.1	5.2	4.1	3.4	7.0	5.4	4.2	3.5	6.9	5.5	4.3	3.5		26.0
	28.0	6.4	5.0	3.9	3.2	6.2	5.1	4.0	3.3	6.1	5.2	4.1	3.3		28.0
	30.0	5.7	4.8	3.8	3.1	5.6	4.9	3.8	3.2	5.5	5.1	3.9	3.2		30.0
	32.0		4.7	3.7	3.0	5.1	4.8	3.7	3.1	5.0	4.9	3.8	3.1		32.0
	34.0			3.5	2.9		4.6	3.6	3.0		4.6	3.7	3.0		34.0
	36.0				2.8			3.5	2.9		4.1	3.6	2.9		36.0
	38.0				2.7			3.4	2.8			3.5	2.8		38.0
40.0								2.7				2.7		40.0	
42.0												2.6		42.0	
Reeves		1	1	1	1	1	1	1	1	1	1	1	1	Reeves	

Note:

Ratings according to EN13000.

Ratings shown in are determined by the strength of the boom or other structural components.

Lifting capacities may vary depending on hook used or with/without auxiliary sheave.

Please refer rated chart in operator's cabin.

LIFTING CAPACITIES



Fixed Jib Lifting Capacity (Without Main Hook Block) (Jib Offset Angle : 30°)

Counterweight: 31.1 t
Carbody Weight: 15.0 t

Unit: metric ton

Boom length (m)		42.7				45.7				48.8				Boom length (m)	
Jib length (m)		9.1	12.2	15.2	18.3	9.1	12.2	15.2	18.3	9.1	12.2	15.2	18.3	Jib length (m)	
Working radius (m)	16.0	9.5				9.5									16.0
	18.0	9.4	6.7			9.5				9.5					18.0
	20.0	8.9	6.4	5.1		9.1	6.5	5.1		9.2	6.6	5.1			20.0
	22.0	8.4	6.1	4.8	4.0	8.4	6.2	4.9	4.0	8.5	6.3	4.9	4.1		22.0
	24.0	7.6	5.8	4.6	3.8	7.6	5.9	4.7	3.8	7.5	6.0	4.7	3.9		24.0
	26.0	6.7	5.6	4.4	3.6	6.6	5.7	4.5	3.7	6.6	5.8	4.5	3.7		26.0
	28.0	6.0	5.4	4.2	3.4	5.9	5.5	4.3	3.5	5.9	5.6	4.3	3.6		28.0
	30.0	5.3	5.2	4.0	3.3	5.3	5.3	4.1	3.3	5.2	5.4	4.1	3.4		30.0
	32.0	4.8	5.0	3.9	3.2	4.8	4.9	4.0	3.2	4.7	4.9	4.0	3.3		32.0
	34.0	4.4	4.5	3.8	3.1	4.3	4.4	3.9	3.1	4.2	4.4	3.9	3.2		34.0
	36.0	3.9	4.1	3.7	3.0	3.9	4.0	3.7	3.0	3.9	3.9	3.8	3.1		36.0
	38.0		3.7	3.6	2.9	3.5	3.6	3.6	2.9	3.5	3.6	3.7	3.0		38.0
	40.0			3.5	2.8			3.4	2.8			3.2	3.4	2.9	40.0
	42.0				2.7			3.1	2.7			2.9	3.0	2.8	42.0
	44.0				2.6				2.7				2.7	2.7	44.0
	46.0													2.6	46.0
	48.0													2.3	48.0
Reeves		1	1	1	1	1	1	1	1	1	1	1	1	Reeves	

Boom length (m)		51.8			
Jib length (m)		9.1	12.2	15.2	18.3
Working radius (m)	18.0	9.5			
	20.0	9.3	6.6		
	22.0	8.5	6.4	5.0	
	24.0	7.5	6.1	4.8	3.9
	26.0	6.6	5.9	4.6	3.8
	28.0	5.9	5.7	4.4	3.6
	30.0	5.2	5.4	4.2	3.5
	32.0	4.7	4.8	4.1	3.4
	34.0	4.2	4.3	4.0	3.3
	36.0	3.7	3.8	3.9	3.2
	38.0	3.3	3.5	3.6	3.1
	40.0	3.0	3.2	3.3	3.0
	42.0		2.9	3.0	2.9
44.0		2.6	2.7	2.6	
46.0			2.4	2.4	
48.0				2.2	
50.0				2.0	
Reeves		1	1	1	1

Note:

Ratings according to EN13000.

Ratings shown in are determined by the strength of the boom or other structural components.

Lifting capacities may vary depending on hook used or with/without auxiliary sheave.

Please refer rated chart in operator's cabin.

SUPPLEMENTAL DATA FOR CLAMSHELL RATING CHART

- Operating radius is the horizontal distance from centerline of rotation to a vertical line through the center of gravity of the load.
- Deduct weight of bucket ,slings and all other load handling accessories from main boom ratings shown.
- Ratings shown are based on freely suspended loads and make no allowance for such factors as wind effect on lifted load, ground conditions, out-of-level, operating speeds or any other condition that could be detrimental to the safe operation of this equipment. The operator, therefore, has the responsibility to judge the existing conditions and reduce lifted loads and operating speeds accordingly.
- Rated loads do not exceed 66% of minimum tipping loads.
- Ratings are for operation on a firm and level surface, up to 1% gradient.
- At radii and boom lengths where no ratings are shown on chart, operation is not intended nor approved.
- Boom inserts and guy lines must be arranged as shown in the "operator's manual".
- Boom hoist reeving is 12 part line.
- Gantry must be in raised position for all conditions.
- Boom backstops are required for all boom lengths.
- The boom should be erected over the front of the crawlers, not laterally.
- Crawler frames must be fully extended for all crane operations.

(CLAMSHELL BUCKET LIFTING)

- The total load that can be lifted is the value for weight of bucket, slings, and all other load handling accessories deducted from main boom ratings shown.
- The weight of bucket and materials must not exceed rated load.
- Optimum bucket should be required according to material.
 $\text{Bucket capacity(m}^3\text{)} \times \text{specified gravity of material(ton/m}^3\text{)} + \text{bucket weight (ton)} = \text{rated load.}$
- Bucket weight must also be decreased according to operating cycle and bucket lowering height.
- Rated loads are determined by stability and boom strength. During simultaneous operations of boom and swing, rapid acceleration or deceleration must be avoided.
- Do not attempt to cast the bucket while swinging or diagonal draw-cutting.

Assembling the counterweight

21.1 ton counterweight
Without carbody weight

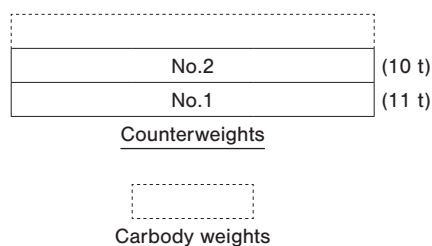

<Reference Information>

Main hoist loads

No. of Parts of Line	1
Maximum Loads (kN)	98
Maximum Loads (t)	10.0

- Lifting capacities listed apply only to the machine as originally manufactured and designed by KOBELCO CONSTRUCTION MACHINERY CO.,LTD. modifications to this machine or use of equipment other than that specified can reduce operating capacity.

Operation of this equipment in excess of rated loads
or disregard of instruction voids the warranty.

LIFTING CAPACITIES



Clamshell Rating Charts Crane Boom Capacity

Counterweight: 21.1 t
Without Carbody Weight
Crawler Fully Extended

Unit: metric ton

Load radius (m) \ Boom length (m)	12.2	15.2	18.3	21.3	24.4				Boom length (m) \ Load radius (m)
5.0	10.0								5.0
6.0	10.0	10.0							6.0
7.0	10.0	10.0	10.0						7.0
8.0	10.0	10.0	10.0	9.5					8.0
9.0	10.0	10.0	10.0	9.5	8.7				9.0
10.0	9.8	9.7	9.6	9.5	8.7				10.0
11.0	9.1	9.0	8.9	8.8	8.7				11.0
12.0		8.3	8.2	8.1	8.0				12.0
13.0		7.7	7.6	7.5	7.4				13.0
14.0		7.1	7.0	6.9	6.8				14.0
15.0			6.5	6.4	6.3				15.0
16.0			6.1	6.0	5.9				16.0
17.0				5.7	5.6				17.0
18.0				5.4	5.3				18.0
19.0				5.2	5.1				19.0
20.0					4.9				20.0
21.0					4.7				21.0
22.0									22.0
23.0									23.0
24.0									24.0
25.0									25.0
26.0									26.0
27.0									27.0
28.0									28.0
29.0									29.0
30.0									30.0
Reeves	1	1	1	1	1				Reeves

Note:
Please refer rated chart in operator's cabin.

SUPPLEMENTAL DATA FOR REDUCED WEIGHTS RATING CHART

- Ratings are calculated to comply with EN13000, ISO4305 and include factors based on a 4 degree tipping angle.
- Operating radius is the horizontal distance from centerline of rotation to a vertical line through the center of gravity of the load.
- Deduct weight of hook block(s), slings and all other load handling accessories from main boom ratings shown.
- Ratings shown are based on freely suspended loads and make no allowance for such factors as wind effect on lifted load, ground conditions, out-of-level, operating speeds or any other condition that could be detrimental to the safe operation of this equipment. The operator, therefore, has the responsibility to judge the existing conditions and reduce lifted loads and operating speeds accordingly.
- Ratings are for operation on a firm and level surface, up to 1% gradient.
- At radii and boom lengths where no ratings are shown on chart, operation is not intended nor approved.
- Boom inserts and guy lines must be arranged as shown in the "operator's manual".
- Boom hoist reeving is 12 part line.
- Gantry must be in raised position for all conditions.
- Boom backstops are required for all boom lengths.
- The boom should be erected over the front of the crawlers, not laterally.
- Ratings inside of boxes are limited by strength of materials.
- The minimum rated load is 1.4(Ton).
- Crawler frames must be fully extended for all crane operations.

(MAIN BOOM)

- The total load that can be lifted is the value for weight of hook block, slings, and all other load handling accessories deducted from main boom ratings shown.

(MAIN BOOM WITH AUXILIARY SHEAVE FRAME)

- The total load that can be lifted is the value for weight of main hook block, slings, and all other load handling accessories deducted from main boom with auxiliary sheave ratings shown.

(AUXILIARY SHEAVE)

- The total load that can be lifted is the value for weight of auxiliary sheave hook block, slings, and all other load handling accessories deducted from auxiliary sheave ratings shown.

Counterweight	Carbody weight	Boom length	
		Without aux.	With aux.
21.1 ton	Without	12.2 m to 57.9 m	12.2 m to 54.9 m

Assembling the counterweight

21.1 ton counterweight
Without carbody weight

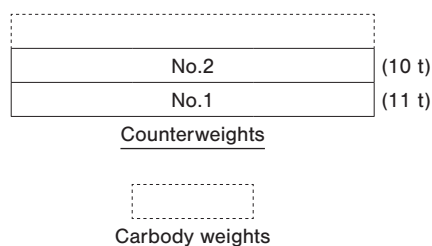

<Reference Information>

Main hoist loads

No. of Parts of Line	1	2	3	4	5
Maximum Loads (kN)	112	224	335	447	559
Maximum Loads (t)	11.4	22.8	34.2	45.6	57.0

No. of Parts of Line	6	7	8
Maximum Loads (kN)	671	784	980
Maximum Loads (t)	68.4	80.0	100.0

Auxiliary hoist loads

No. of Parts of Line	1
Maximum Loads (kN)	108
Maximum Loads (t)	11.0

Weight of hook block					
Hook Block	100 t	70 t	50 t	35 t	11 t Ball Hook
Weight (t)	1.3	0.9	0.85	0.7	0.3

- Lifting capacities listed apply only to the machine as originally manufactured and designed by KOBELCO CONSTRUCTION MACHINERY CO.,LTD. modifications to this machine or use of equipment other than that specified can reduce operating capacity.

Operation of this equipment in excess of rated loads or disregard of instruction voids the warranty.

LIFTING CAPACITIES



Reduced Weights Rating Charts Crane Boom Lifting Capacity

Counterweight: 21.1 t
Without Carbody Weight
Crawler Fully Extended

Unit: metric ton

Load radius (m) \ Boom length (m)	12.2	15.2	18.3	21.3	24.4	27.4	30.5	33.5	36.6	39.6				Boom length (m) \ Load radius (m)
3.9	73.8	76.5	71.0											3.9
4.0	72.9	73.9	68.7	4.3m/58.8										4.0
4.5	67.1	63.1	59.1	55.7	4.7m/49.9									4.5
5.0	54.8	54.8	51.6	48.4	46.4	5.1m/42.2								5.0
5.5	46.2	46.2	45.8	43.2	41.6	39.7	5.6m/37.1							5.5
6.0	40.0	39.9	39.7	39.1	37.6	36.0	34.5	33.1	6.4m/29.8	6.8m/26.9				6.0
7.0	31.3	31.2	31.1	30.9	30.6	30.3	29.2	28.2	27.1	26.2				7.0
8.0	25.7	25.6	25.4	25.4	25.4	25.3	25.2	24.4	23.6	22.8				8.0
9.0	21.7	21.6	21.4	21.4	21.4	21.4	21.3	21.3	20.8	20.1				9.0
10.0	18.8	18.6	18.5	18.5	18.5	18.5	18.4	18.3	18.2	18.0				10.0
12.0	11.8m/15.0	14.5	14.4	14.4	14.4	14.3	14.2	14.2	14.0	13.9				12.0
14.0		11.9	11.7	11.7	11.7	11.6	11.5	11.4	11.3	11.2				14.0
16.0		14.4m/11.5	9.8	9.8	9.8	9.7	9.6	9.5	9.4	9.3				16.0
18.0			17.0m/9.0	8.4	8.3	8.3	8.1	8.1	7.9	7.8				18.0
20.0				19.6m/7.6	7.2	7.1	7.0	6.9	6.8	6.7				20.0
22.0					6.4	6.3	6.1	6.1	5.9	5.8				22.0
24.0					22.3m/6.3	5.6	5.4	5.3	5.2	5.1				24.0
26.0						24.9m/5.3	4.8	4.8	4.6	4.5				26.0
28.0							27.6m/4.4	4.3	4.1	4.0				28.0
30.0								3.8	3.7	3.6				30.0
32.0								30.2m/3.8	3.3	3.2				32.0
34.0									32.9m/3.2	2.9				34.0
36.0										35.5m/2.7				36.0
38.0														38.0
40.0														40.0
44.0														44.0
Reeves	7	7	7	6	5	4	4	3	3	3				Reeves

Load radius (m) \ Boom length (m)	42.7	45.7	48.8	51.8	54.9	57.9								Boom length (m) \ Load radius (m)
4.5														4.5
5.0														5.0
5.5														5.5
6.0														6.0
7.0	7.3m/24.1	7.7m/22.2												7.0
8.0	22.0	21.4	8.1m/19.8	8.5m/17.2										8.0
9.0	19.5	18.9	18.3	16.6	14.5	9.4m/12.5								9.0
10.0	17.4	16.9	16.4	15.5	13.5	11.9								10.0
12.0	13.8	13.7	13.5	13.1	11.9	10.4								12.0
14.0	11.1	11.1	11.1	11.0	10.6	9.3								14.0
16.0	9.1	9.1	9.1	9.0	8.9	8.3								16.0
18.0	7.7	7.7	7.7	7.6	7.5	7.4								18.0
20.0	6.6	6.6	6.5	6.4	6.3	6.3								20.0
22.0	5.7	5.7	5.6	5.5	5.4	5.4								22.0
24.0	4.9	4.9	4.9	4.8	4.7	4.6								24.0
26.0	4.3	4.3	4.3	4.2	4.1	4.0								26.0
28.0	3.8	3.8	3.8	3.7	3.6	3.5								28.0
30.0	3.4	3.4	3.4	3.3	3.1	3.0								30.0
32.0	3.1	3.1	3.0	2.9	2.7	2.6								32.0
34.0	2.7	2.7	2.6	2.5	2.3	2.3								34.0
36.0	2.4	2.4	2.3	2.2	2.0	1.9								36.0
38.0	2.1	2.1	2.0	1.9	1.7	1.7								38.0
40.0	38.1m/2.1	1.9	1.8	1.6	1.5	1.4								40.0
44.0		40.8m/1.8	43.4m/1.4											44.0
48.0														48.0
52.0														52.0
Reeves	3	2	2	2	2	2								Reeves

Ratings according to EN13000.

Ratings shown in are determined by the strength of the boom or other structural components.

Lifting capacities may vary depending on hook used or with/without auxiliary sheave.

Please refer rated chart in operator's cabin.

SUPPLEMENTAL DATA FOR BARGE RATING CHART

- Operating radius is the horizontal distance from centerline of rotation to a vertical line through the center of gravity of the load.
- Deduct weight of hook block(s), slings and all other load handling accessories from main boom ratings shown.
- Condition of barge stability this rating chart were determined under the condition below. The stability of barge shall meet below condition. During operation the machinery static inclination against horizontal level.

(A) Both sides (right & left) of machine

Maximum inclination shall be within 1.5 degrees

(B) Front & backward of machine

Maximum inclination shall be within 3.0 degrees

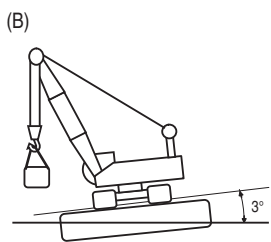
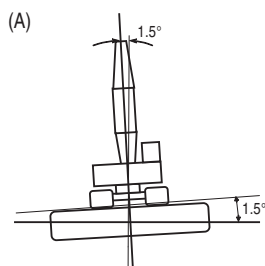
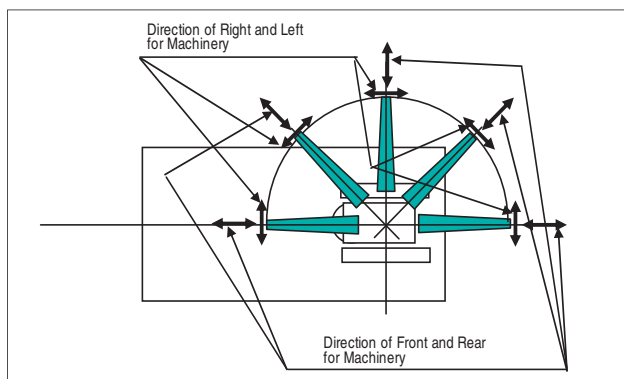

- Working area shall be inshore and smooth water.
- Applicable regulations for structure
 - Japanese construction codes for mobile crane
 - * Regulation of class of shipping (abs, lloyd, bv, nk, etc) are not adapted.
- At radii and boom lengths where no ratings are shown on chart, operation is not intended nor approved.
- Boom inserts and guy lines must be arranged as shown in the "operator's manual".
- Boom hoist reeving is 12 part line.
- Gantry must be in raised position for all conditions. Boom backstops are required for all boom lengths.
- The boom should be erected over the front of the crawlers, not laterally.
- Ratings inside of boxes are limited by strength of materials.
- The minimum rated load is 1.4(ton).
- Crawler frames must be fully extended for all crane operations.
- The machinery should be fastened to the deck of the barge to prevent tip over and sliding.
- Towing area

Towing area shall be within coastal area and quiet wave condition. Offshore and open sea is not considered for this machinery. Depend on the height of wave, counterweight shall be reduced during towing.

(Main boom)

- The total load that can be lifted is the value for weight of hook block, slings, and all other load handling accessories deducted from main boom ratings shown.

(Main boom with auxiliary sheave frame)

- The total load that can be lifted is the value for weight of main hook block, slings, and all other load handling accessories deducted from main boom with auxiliary sheave ratings shown.

(AUXILIARY SHEAVE)

- The total load that can be lifted is the value for weight of auxiliary sheave hook block, slings, and all other load handling accessories deducted from auxiliary sheave ratings shown.

<Reference Information>

Main hoist loads

No. of Parts of Line	1	2	3	4	5
Maximum Loads (kN)	112	224	335	447	490
Maximum Loads (t)	11.4	22.8	34.2	45.6	50.0

Auxiliary hoist loads

No. of Parts of Line	1
Maximum Loads (kN)	108
Maximum Loads (t)	11.0

Weight of hook block					
Hook Block	100 t	70 t	50 t	35 t	11 t Ball Hook
Weight (t)	1.3	0.9	0.85	0.7	0.3

- Lifting capacities listed apply only to the machine as originally manufactured and designed by KOBELCO CONSTRUCTION MACHINERY CO.,LTD. modifications to this machine or use of equipment other than that specified can reduce operating capacity.

Operation of this equipment in excess of rated loads or disregard of instruction voids the warranty.

Assembling the counterweight

31.1 ton counterweight
15.0 ton carbody weight

No.3	(10 t)
No.2	(10 t)
No.1	(11 t)

Counterweights

(7.5 t × 2 pieces)
Carbody weights

LIFTING CAPACITIES



Barge Rating Chart Crane Boom Lifting Capacity

Counterweight: 31.1 t
Carbody Weight: 15.0 t
Crawler Fully Extended

Unit: metric ton

Load radius (m)	Boom length (m)	15.2	18.3	21.3	24.4	27.4	30.5	33.5	36.6	Boom length (m)	Load radius (m)
4.5	4.6m/50.0										4.5
5.0	44.8										5.0
5.5	37.0	40.4									5.5
6.0	31.5	36.9	6.2m/35.5	6.9m/31.4							6.0
7.0	26.7	31.4	31.2	30.9	7.5m/28.1						7.0
8.0	23.0	26.6	26.5	26.4	26.3	8.2m/24.9	8.9m/22.2				8.0
9.0	20.1	22.9	22.8	22.7	22.6	22.5	22.1	9.6m/19.4			9.0
10.0	15.8	20.3	20.2	20.1	20.0	19.9	19.8	19.1			10.0
12.0	11.9	16.1	16.0	15.9	15.8	15.7	15.6	15.5			12.0
14.0	14.4m/10.8	12.6	12.8	12.7	12.6	12.5	12.4	12.3			14.0
16.0		10.4	10.8	10.8	10.7	10.6	10.5	10.4			16.0
18.0		17.0m/8.5	8.7	9.0	9.2	9.1	9.0	8.9			18.0
20.0			19.6m/7.4	7.7	8.0	8.1	8.0	7.9			20.0
22.0				6.5	6.9	7.0	7.0	6.9			22.0
24.0				22.3m/6.3	5.9	6.1	6.2	6.1			24.0
26.0					24.9m/5.5	5.2	5.4	5.3			26.0
28.0						27.6m/4.6	4.6	4.6			28.0
30.0							4.0	4.0			30.0
32.0							30.2m/3.9	3.5			32.0
34.0								32.9m/3.2			34.0
Reeves		5	4	4	3	3	3	2	2		Reeves

Note:

Ratings according to Japanese construction codes for mobile cranes and Japanese safety ordinance on cranes, etc.

Ratings shown in are determined by the strength of the boom or other structural components.

Lifting capacities may vary depending on hook used or with/without auxiliary sheave.

Please refer rated chart in operator's cabin.

TRANSPORTATION PLAN

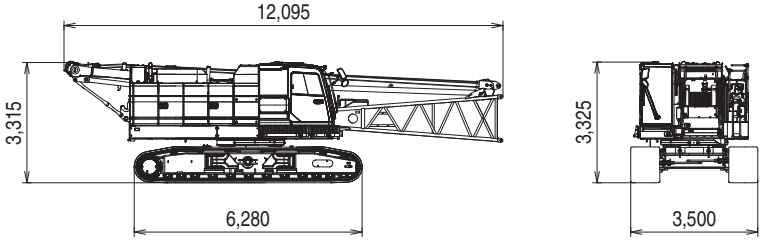
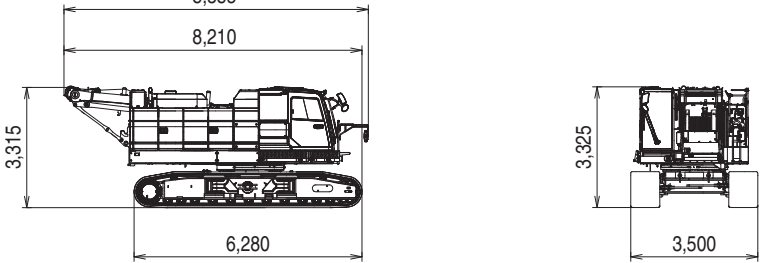
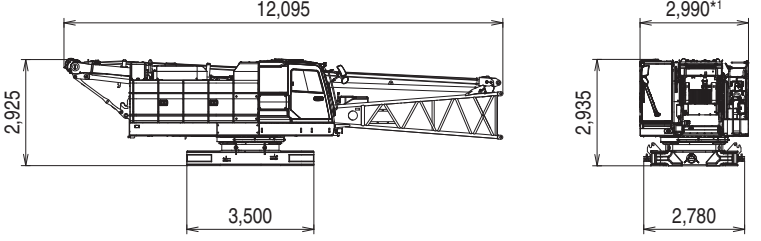
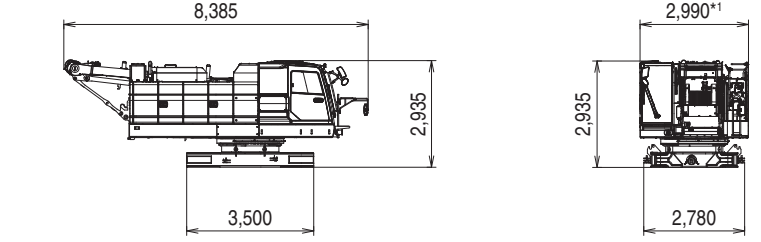
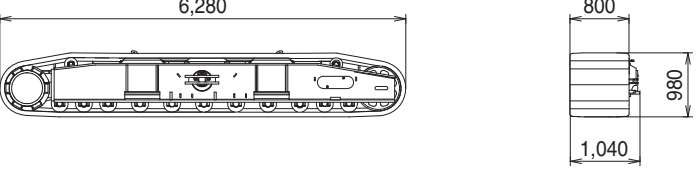
Name	Dimension	Weight (kg)
Base Machine <ul style="list-style-type: none"> • Boom base • Gantry • Crawler • Wire rope (Front / rear / boom hoist) 		40,415
Base Machine <ul style="list-style-type: none"> • Gantry • Crawler • Wire rope (Front / rear / boom hoist) 		38,400
Base Machine <ul style="list-style-type: none"> • Boom base • Gantry • Wire rope (Front / rear / boom hoist) • Without crawler • Without side steps 		25,805
Base Machine <ul style="list-style-type: none"> • Gantry • Wire rope (Front / rear / boom hoist) • Without crawler • Without side steps 		23,790
Crawler		7,180

*1 With the side step on cabin side : 3,170
 With the side steps on the both sides : 3,340

PARTS AND ATTACHMENTS

Base Machine

Boom base, Gantry, Crawler, Wire rope (Front/rear/boom hoist)
Weight: 40,415 kg Width: 3,500 mm

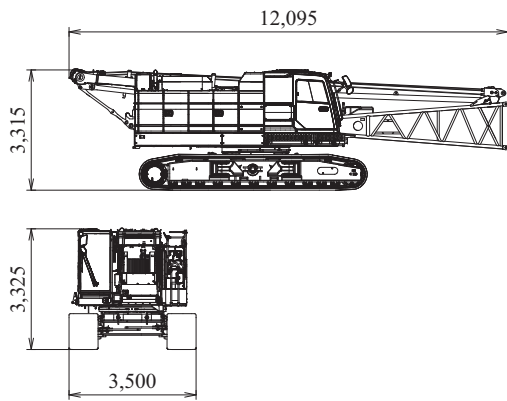

Crawler

Weight: 7,180 kg

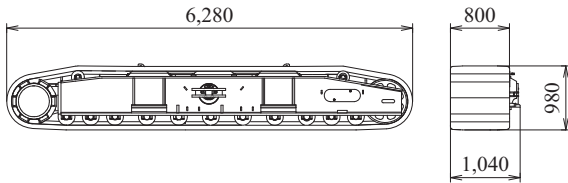

Counterweight No.1

Weight: 11,000 kg

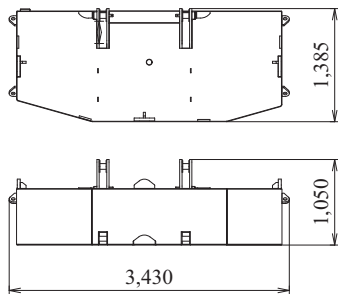

Counterweight No.2, No.3

Weight: 10,000 kg

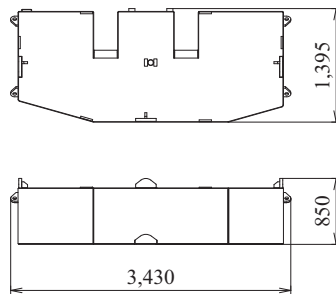

Carbody Weight

Weight: 7,500 kg

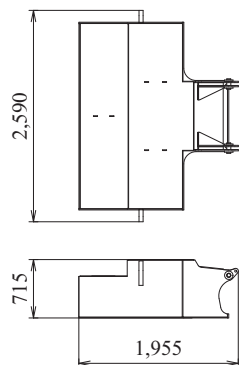

Narrow Gauge Carbody Weight (Optional)

Weight: 7,500 kg

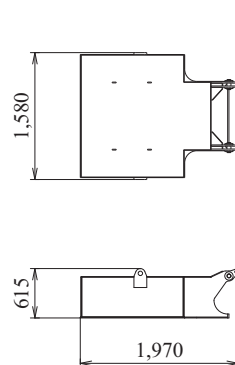

Boom Tip

Weight: 1,220 kg

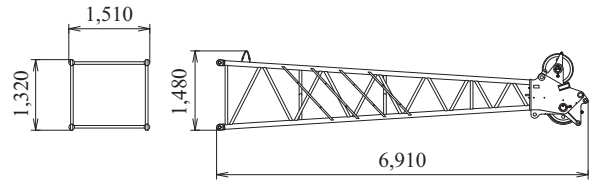

Boom Base

Weight: 1,100 kg

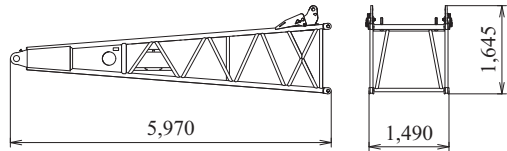

3.0 m

Boom Insert

Weight: 300 kg

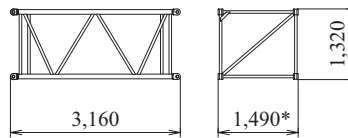

6.1 m

Boom Insert

Weight: 520 kg

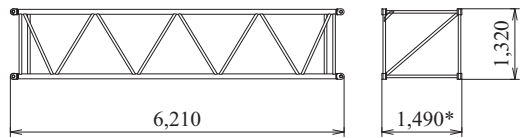

12.2 m

Boom Insert

Weight: 950 kg

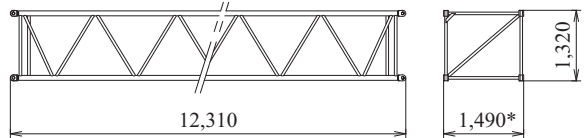

12.2 m

Boom Insert (with Lug)

Weight: 1,200 kg

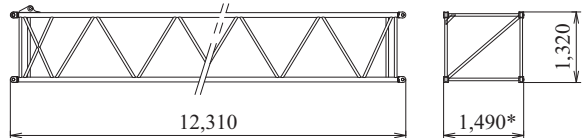

Crane Backstop

Weight: 270 kg (1 piece)

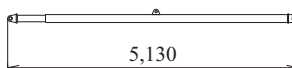

*Without pins

Jib Tip
Weight: 280 kg

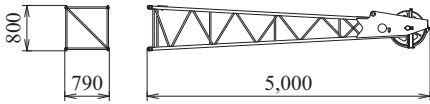

Jib Base
Weight: 200 kg

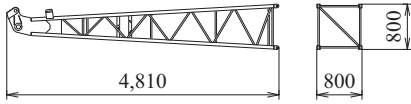

3.0 m Jib Insert
Weight: 100 kg

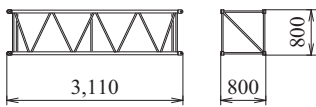

6.1 m Jib Insert
Weight: 180 kg

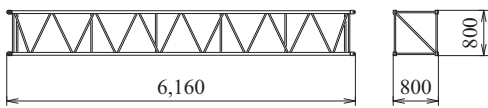

Strut
Weight: 250 kg

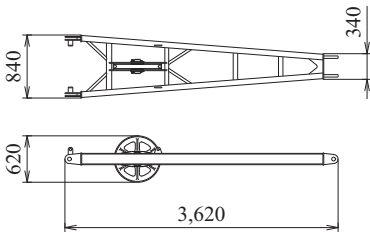

Auxiliary Sheave
Weight: 195 kg

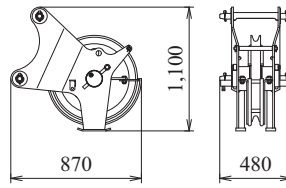

Upper Spreader
Weight: 280 kg

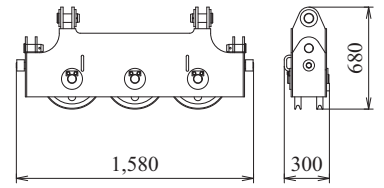

2 Part-line Aux. Sheave (Optional)
Weight: 470 kg

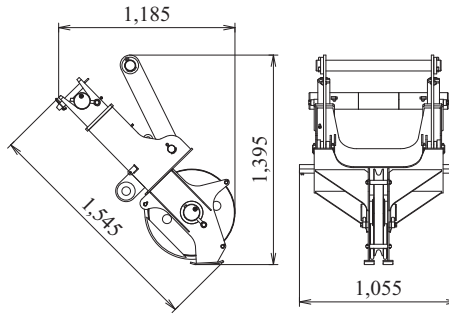

Ball Hook
Weight: 290 kg

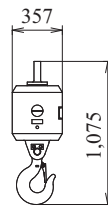

35 t Hook
Weight: 700 kg

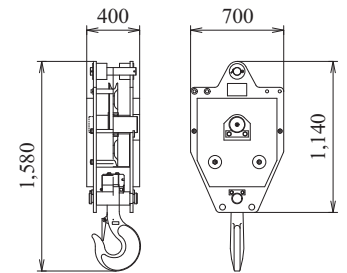

50 t Hook
Weight: 860 kg

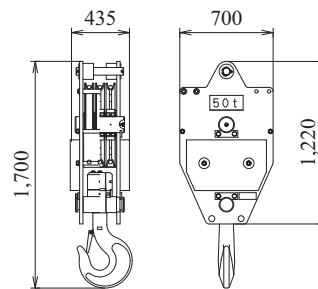

70 t Hook
Weight: 900 kg

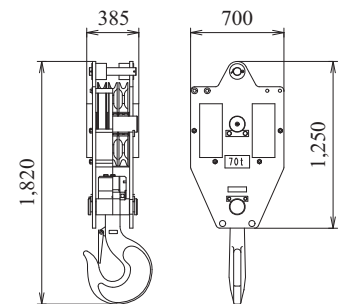

100 t Hook
Weight: 1,300 kg

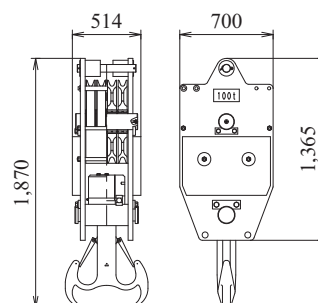

Note: This catalog may contain photographs of machines with specifications, attachments and optional equipment not certified for operation in your country. Please consult KOBELCO for those items you may require. Due to our policy of continual product improvements all designs and specifications are subject to change without advance notice.

Copyright by KOBELCO CONSTRUCTION MACHINERY CO., LTD. No part of this catalog may be reproduced in any manner without notice.

KOBELCO CONSTRUCTION MACHINERY CO., LTD.

Inquiries To:

5-15, Kitashinagawa 5-chome, Shinagawa-ku, Tokyo 141-8626 JAPAN

Tel: +81-3-5789-2121 Fax: +81-3-5789-3372

URL: <https://www.kobelcocm-global.com>