

Hydraulic Crawler Crane

SL6000G

Model : SL6000G

Max. Lifting Capacity : 550 t x 8.3 m
Max. Crane Boom Length : 126.0 m (Long Boom)
Max. Luffing Jib Combination: 84.0 m + 84.0 m

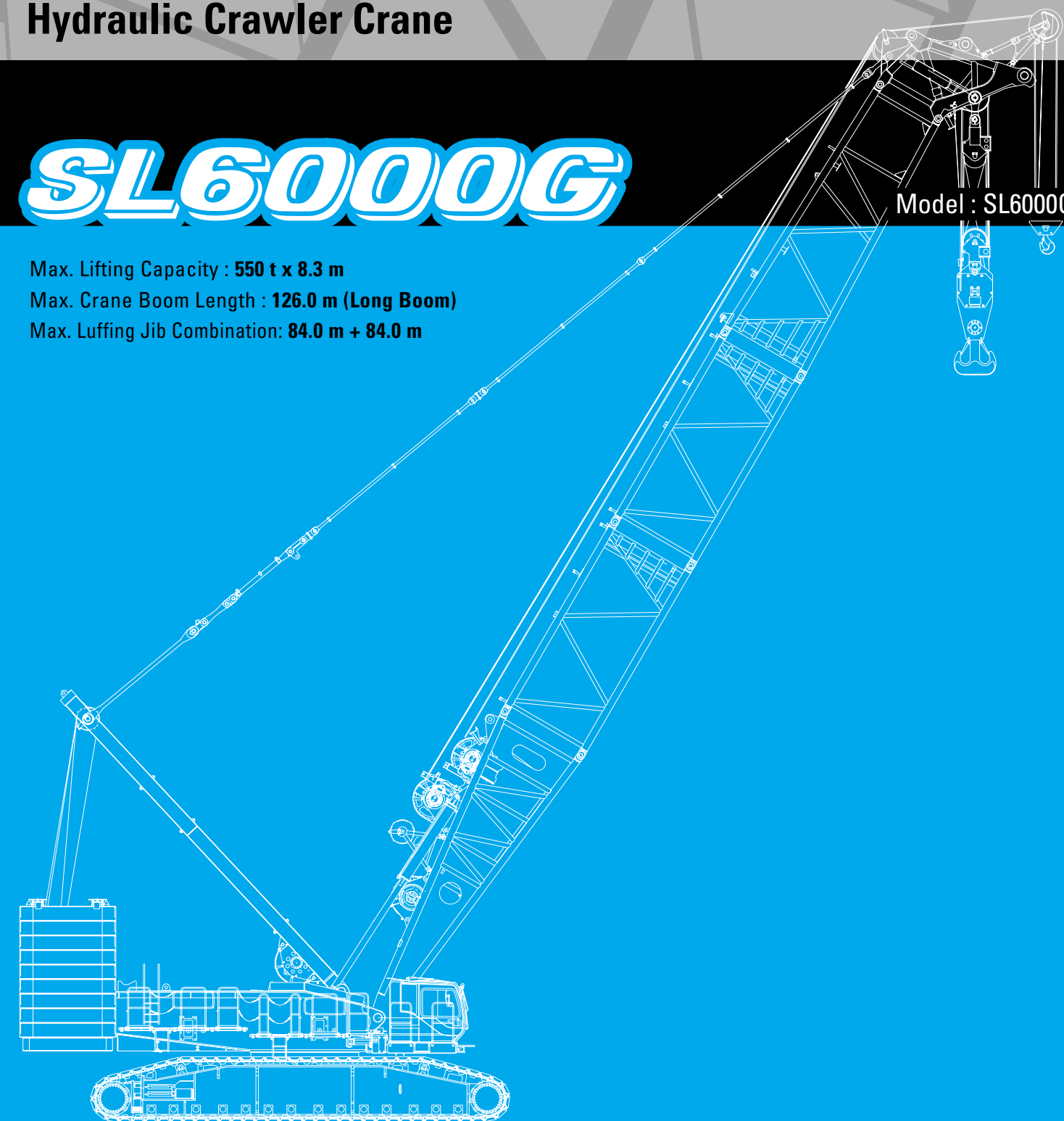

Note: This catalog may contain photographs of machines with specifications, attachments and optional equipment not certified for operation in your country. Please consult KOBELCO for those items you may require. Due to our policy of continual product improvements all designs and specifications are subject to change without advance notice.

Copyright by KOBELCO CRANES CO., LTD. No part of this catalog may be reproduced in any manner without notice.



KOBELCO CRANES CO., LTD.

17-1, Higashigotanda 2-chome, Shinagawa-ku, Tokyo 141-8626 JAPAN
Tel: +81-3-5789-2130 Fax: +81-3-5789-3372

URL: <http://www.kobelco-cranes.com/>

Inquiries To:

KOBELCO

CONFIGURATION

HYDRAULIC CRAWLER CRANE SL6000G

The following abbreviations are used throughout this catalog:
STD: Standard HL: Heavy Lift SHL: Super Heavy Lift

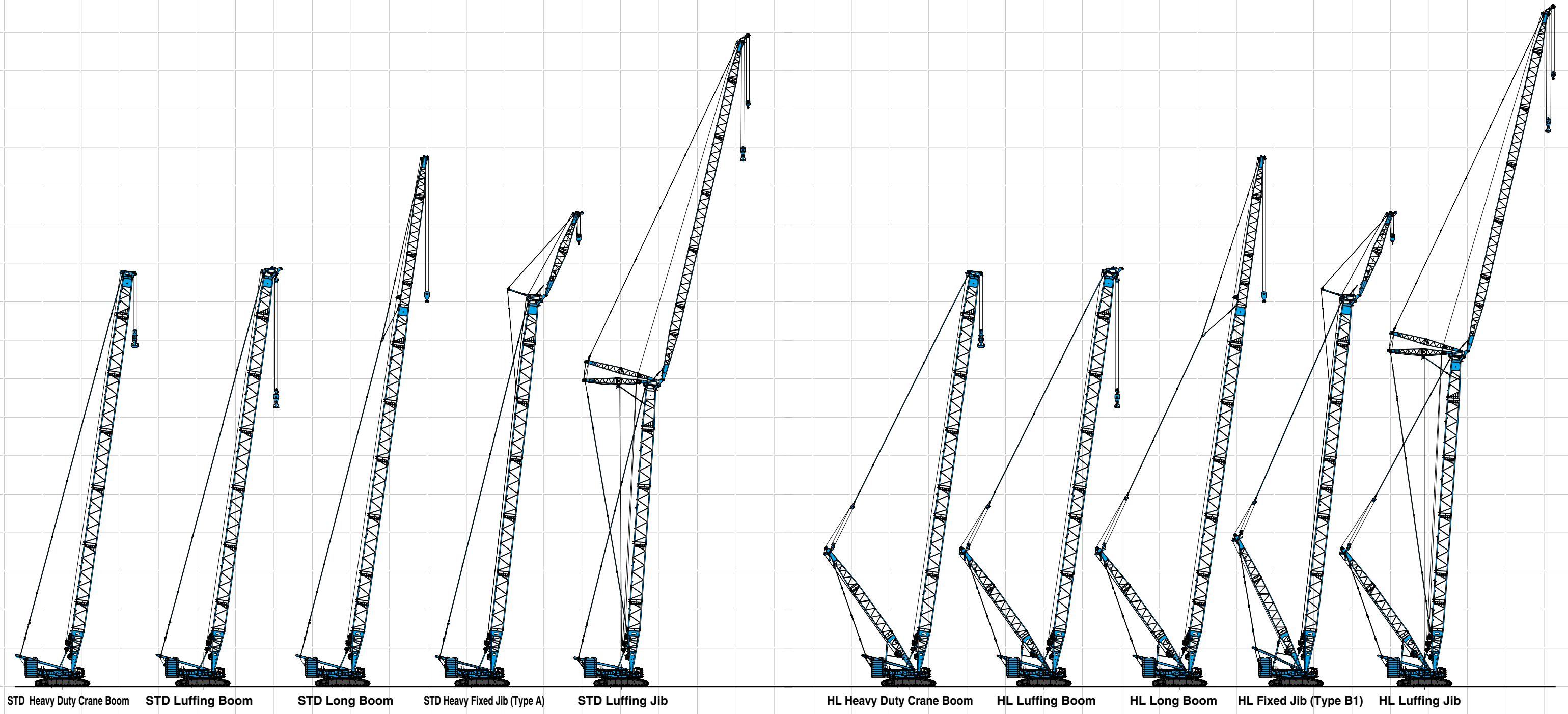

STD Heavy Duty Crane Boom STD Luffing Boom STD Long Boom STD Heavy Fixed Jib (Type A) STD Luffing Jib HL Heavy Duty Crane Boom HL Luffing Boom HL Long Boom HL Fixed Jib (Type B1) HL Luffing Jib

STD	Heavy Duty Crane Boom	Luffing Boom	Long Boom	Heavy Fixed Jib (Type A)	Luffing Jib
Max. Lifting Capacity:	450 t x 6.7 m	300 t x 10.0 m	98 t x 18.0 m	105 t x 20.0 m	195.1 t x 14.0 m
Max. Boom Length:	84 m	84 m	108 m	–	–
Max. Combination:	–	–	–	78 m + 18 m	60 m + 72 m

HL	Heavy Duty Crane Boom	Luffing Boom	Long Boom	Fixed Jib (Type B1)	Luffing Jib
Max. Lifting Capacity:	370 t x 8.3 m	300 t x 9.3 m	98 t x 20.0 m	120 t x 20.0 m	200 t x 14.4 m
Max. Boom Length:	84 m	84 m	108 m	–	–
Max. Combination:	–	–	–	78 m + 18 m	66 m + 72 m

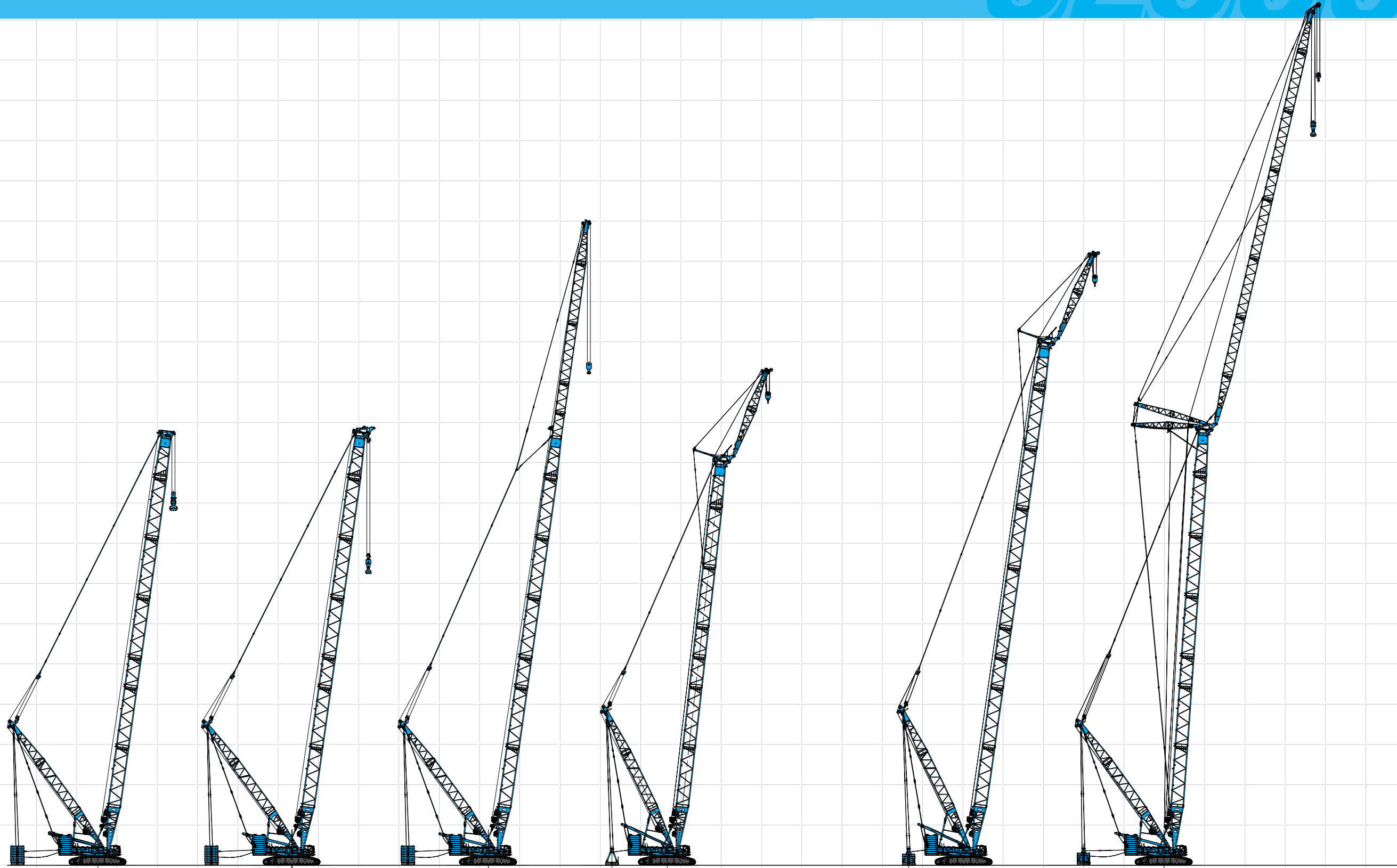

SHL Heavy Duty Crane Boom

SHL Luffing Boom

SHL Long Boom

SHL Heavy Fixed Jib (Type B2)

SHL Heavy Fixed Jib (Type C)

SHL Luffing Jib

SHL	Heavy Duty Crane Boom	Luffing Boom	Long Boom	Heavy Fixed Jib (Type B2)
Max. Lifting Capacity:	550 t x 8.3 m	300 t x 20.0 m	98 t x 30.0 m	120 t x 20.0 m
Max. Boom Length:	84 m	84 m	126 m	–
Max. Combination:	–	–	–	78 m + 18 m

SHL	Heavy Fixed Jib (Type C)	Luffing Jib
Max. Lifting Capacity:	105 t x 30.0 m	200 t x 14.4 m
Max. Boom Length:	–	–
Max. Combination:	102 m + 18 m	84 m + 84 m

CONTENTS

- Configuration 1
- Specifications 5
- General Dimensions 7

STANDARD

- Boom and Jib Arrangements 9
- Working Ranges 12
- Crane Boom Supplemental Data 19
- Heavy Fixed Jib Supplemental Data 21
- Luffing Jib Supplemental Data 23
- Heavy Duty Crane Boom Lifting Capacities 27
- Long Boom Lifting Capacities 27
- Heavy Fixed Jib Lifting Capacities 27
- Luffing Boom Lifting Capacities 28
- Luffing Jib Lifting Capacities 29

HEAVY LIFT

- Boom and Jib Arrangements 33
- Working Ranges 36
- Heavy Duty Crane Boom Lifting Capacities 43
- Long Boom Lifting Capacities 44
- Heavy Fixed Jib Lifting Capacities 44
- Luffing Boom Lifting Capacities 45
- Luffing Jib Lifting Capacities 46

SUPER HEAVY LIFT

- Boom and Jib Arrangements 49
- Working Ranges 53
- Heavy Duty Crane Boom Lifting Capacities 61
- Long Boom Lifting Capacities 62
- Heavy Fixed Jib Lifting Capacities 63
- Luffing Boom Lifting Capacities 64
- Luffing Jib Lifting Capacities 65

- Transportation Plan 75
- Parts and Attachments 77

Power Plant

Model: Hino diesel engine E13C-VV
Type: Water-cooled, direct fuel injection, with turbocharger
 Complies with NRMM (Europe) Stage III B / US EPA Interim Tier 4.
Displacement: 12,913 liters
Rated Power: 320 kW/2,000 min⁻¹ (Max Power: 330 kW/1,800 min⁻¹)
Max. torque: 1,930 N·m/1,300 min⁻¹
Cooling system: Water-cooled
Starter: 24 V/6 kW
Radiator: Corrugated type core, thermostatically controlled
Air cleaner: Dry type with replaceable paper element
Throttle: Twist grip type hand throttle, electrically actuated
Fuel filter: Replaceable paper element with water separator.
Batteries: Two 12V x 136Ah/5HR capacity batteries, parallel connected.
Fuel tank capacity: 600 liters

Hydraulic System

Seven variable displacement piston pumps are driven by heavy-duty pump drive. Two variable displacement pumps are used in H1 (main hook hoist) and right hand side propel circuit. Two variable displacement pumps are used in H2 (auxiliary hook hoist) and left hand side propel circuit. One of the other two pumps is used in W1 (boom), W2 (jib) or W3 (SHL mast) hoist circuit, and the other is used in the swing circuit. One displacement piston pump is used for W1 or W3 hoist speed up.
Control: Full-flow hydraulic control system for infinitely variable pressure to all winches, propel and swing. Controls respond instantly to the touch, delivering smooth function operation.
Cooling: Oil-to-air heat exchanger (plate-fin type)
Filtration: Full-flow and bypass type with replaceable element

Max. relief valve pressure: 32.0 MPa {326 kgf/cm²}
Hydraulic Tank capacity: 710 liters

Boom Hoisting System

Powered by a hydraulic motor through a planetary reducer.
Brake: A spring-set, hydraulically released multiple-disc brake is mounted on the boom hoist motor and operated through a counter-balance valve.
Drum lock: External ratchet for locking drum.
Drum: Double drum, grooved for 28 mm dia. wire rope.
Line speed: Single line on first drum layer
Hoisting/Lowering: 28~2 m/min x 2
Boom hoist reeving: 30 parts of 28 mm dia. high strength wire rope
Boom backstops: Required for all boom lengths

Load Hoist System

H1 and H2 drums for load hoist powered by a hydraulic variable plunger motors, driven through planetary reducers.
Brake: A spring-set, hydraulically released multiple-disc brake is mounted on the hoist motor and operated through a counter-balance valve.
Drum lock: External ratchet for locking drum.
Drums:
H1 and H2:
 640 mm P.C.D. x 1,367 mm Lg. wide drum, grooved for 28 mm wire rope. Rope capacity is 830 m storage length.

Note: Rope lengths listed above denote drum capacity and may differ from actual rope lengths supplied when machinery is shipped.

Line speed: 110 ~ 3 m/min
 Single line on the first layer
Rated line pull: 137 kN {14.0 tf}

Swing System

Swing unit is powered by hydraulic motor driving spur gears through planetary reducers (4 sets), the swing system provides 360° rotation.
Swing parking brakes: A spring-set, hydraulically released multiple-disc brake is mounted on swing motor.
Swing circle: Triple-row roller bearing with an integral internally cut swing gear.
Swing speed: 0.9 min⁻¹ {rpm}

Upper Structure

Torsion-free precision machined upper frame. All components are located clearly and service friendly. Engine with low noise level.

Cab & Control

Totally enclosed, full vision cab with safety glass, fully adjustable, can be tilted up to 15 degree, high backed seat with a head-rest and armrests, and intermittent wiper and window washer (sky light and front window.)
Cab fittings:
 Air conditioner, convenient compartment (for tool), cup holder, ashtray, cigarette lighter, sun visor, roof blind, tinted glass, floor mat, foot-rest, shoe tray
Controls:
 Five adjustable levers for all winches and swing controls

Lower Structure

Steel-welded carbody with axles. Crawler assemblies are designed with quick disconnect feature for individual removal as a unit from axles. Crawler belt tension is maintained by hydraulic jack force on the track-adjusting bearing block.
Crawler drive: Two independent hydraulic propel drive is built into each crawler side frame. Each drive consists of a hydraulic motor propelling a driving tumbler through a planetary gear box. Hydraulic motor and gear box are built into the crawler side frame within the shoe width.
Crawler brakes: Spring-set, hydraulically released parking brakes are built into each propel drive.
Steering mechanism: A hydraulic propel system provides both skid steering (driving one track only) and counter-rotating steering (driving each track in opposite directions).
Track rollers: Sealed track rollers.
Shoes (flat): 1,500 mm wide each crawler
Max. travel speed: 1.0/0.6 km/h
Max. gradeability: 20%

Weight

Including base machine, counterweights =200 metric ton, carbody weights = 50 metric ton, 24 m standard heavy duty boom and 450 metric ton hook block. Not include quick connection device and upper translifter.

Weight: 444 metric ton
Ground pressure: 142 kPa {1.5 kgf/cm²}

Attachment

Boom and Jib:
 Welded lattice construction using tubular, high-tensile steel chords with pin connections between sections.

	Min. Length (Min. Combination)	Max. Length (Max. Combination)
--	-----------------------------------	-----------------------------------

STANDARD		
Heavy Duty Boom	24 m	84 m
Luffing Boom	30 m	84 m
Long Boom	90 m	108 m
Heavy Fixed Jib	66 m + 18 m	78 m + 18 m
Luffing Jib	30 m + 24 m	60 m + 72 m

HEAVY LIFT		
Heavy Duty Boom	36 m	84 m
Luffing Boom	36 m	84 m
Long Boom	90 m	108 m
Heavy Fixed Jib	66 m + 18 m	78 m + 18 m
Luffing Jib	36 m + 24 m	66 m + 72 m

SUPER HEAVY LIFT		
Heavy Duty Boom	36 m	84 m
Luffing Boom	36 m	84 m
Long Boom	90m	126 m
Heavy Fixed Jib	66 m + 18 m	78 m + 18 m
	84 m + 18 m	102 m + 18 m
Luffing Jib	36 m + 24 m	84 m + 84 m

Main Specifications (Model: SL6000G)

Lift Enhancer	STD	HL	SHL
HL Mast	-	30 m	30 m
Additional Weight	-	-	~250 t
Heavy Duty Crane Boom			
Max. Lifting Capacity	450 t	370 t	550 t
	6.7 m	8.3 m	8.3 m
Length	24 ~ 84 m	36 ~ 84 m	36 ~ 84 m
Luffing Boom			
Max. Lifting Capacity	300 t	300 t	300 t
	9.3 m	9.3 m	20.0 m
Length	30 ~ 84 m	36 ~ 84 m	36 ~ 84 m
Long Boom			
Max. Lifting Capacity	90 ~ 108 m	90 ~ 108 m	90 ~ 126 m
	98 t	98 t	98 t
Length	18 m	20 m	30 m
Heavy Fixed Jib			
Max. Lifting Capacity	105 t	120 t	120 t
	20.0 m	20.0 m	20 m
Max. Combination (Boom) (Jib)	78 m	78 m	78 m
	18 m	18 m	18 m
Max. Combination (Boom) (Jib)	78 m	78 m	78 m
	18 m	18 m	18 m
Luffing Jib			
Max. Lifting Capacity	195.1 t	200 t	200 t
	14 m	14.4 m	14.4 m
Max. Combination (Boom) (Jib)	60 m	66 m	84 m
	72 m	72 m	84 m
Luffing Angle	66° ~ 86°		

Power Plant	
Model	Hino E13C-VV
Engine Output	320 kW/2,000 min ⁻¹ {rpm}
Fuel Tank Capacity	600 liters
Hoist Winch (H1, H2)	
Max. Line Speed	110 m/min (1st layer)
Rated Line Pull (Single line)	137 kN {14.0 tf}
Wire Rope Diameter	28 mm
Wire Rope Length	830 m
Working Speed	
Swing	0.9 min ⁻¹ {rpm}
Travel	1.0/0.6 km/h
Hydraulic System	
Pumps	7 variable displacement
Max. Pressure	32 MPa {326 kgf/cm ² }
Hydraulic Tank Capacity	710 liters
Weight	
Working Weight*3	Approx. 444 t
Ground Pressure*3	142 kPa {1.5 kgf/cm ² }
Counterweight	Upper: 200 metric tons
	Lower: 50 metric tons

*1 Heavy Fixed Jib Type B2

*2 Heavy Fixed Jib Type C

*3 Including base machine, counterweights =200 metric ton, carbody weights = 50 metric ton, 24 m boom with heavy boom tip and 450 metric ton hook block. Not include quick connection device and upper translifter.

Crane Boom

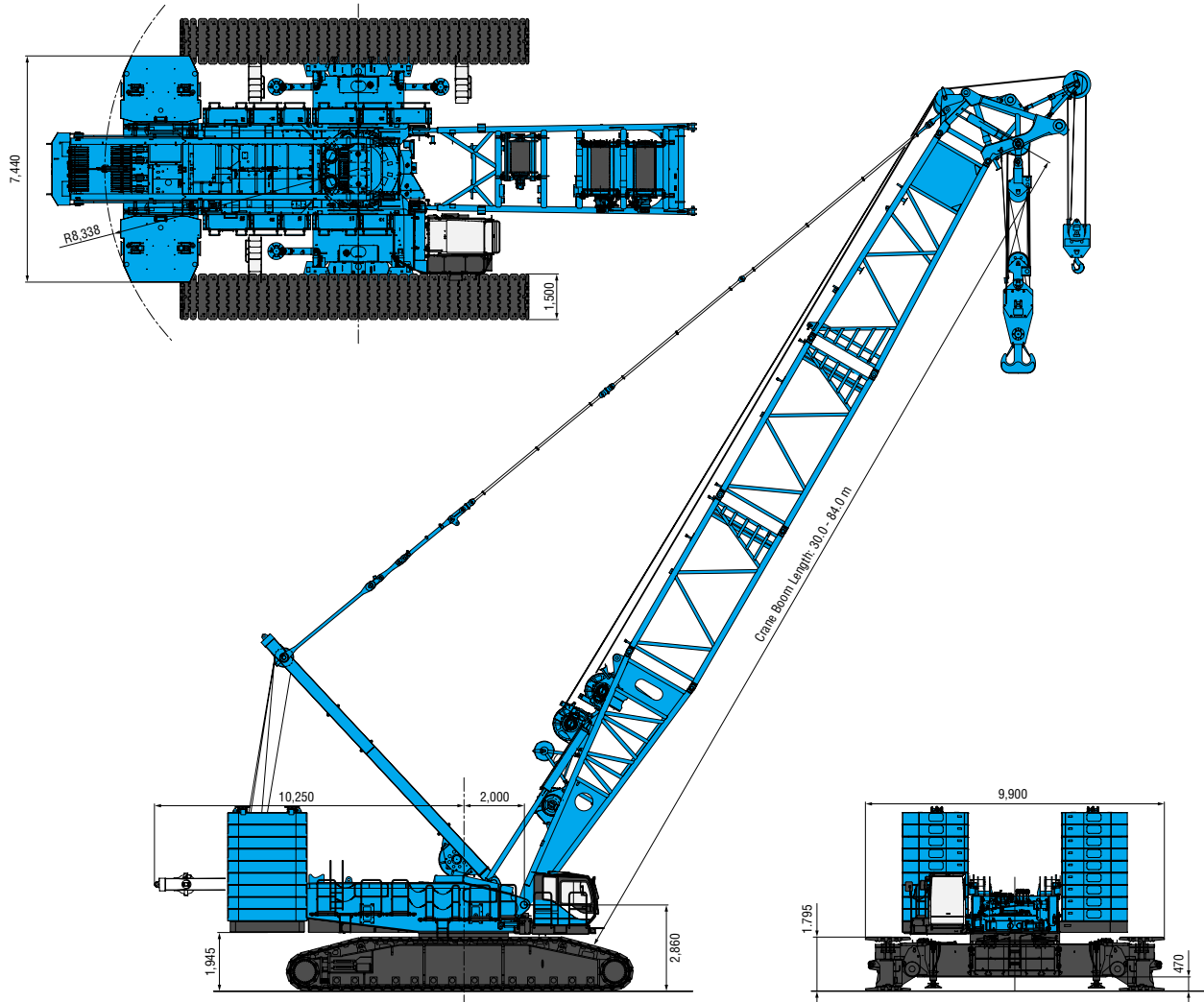

Unit: mm

Luffing Jib

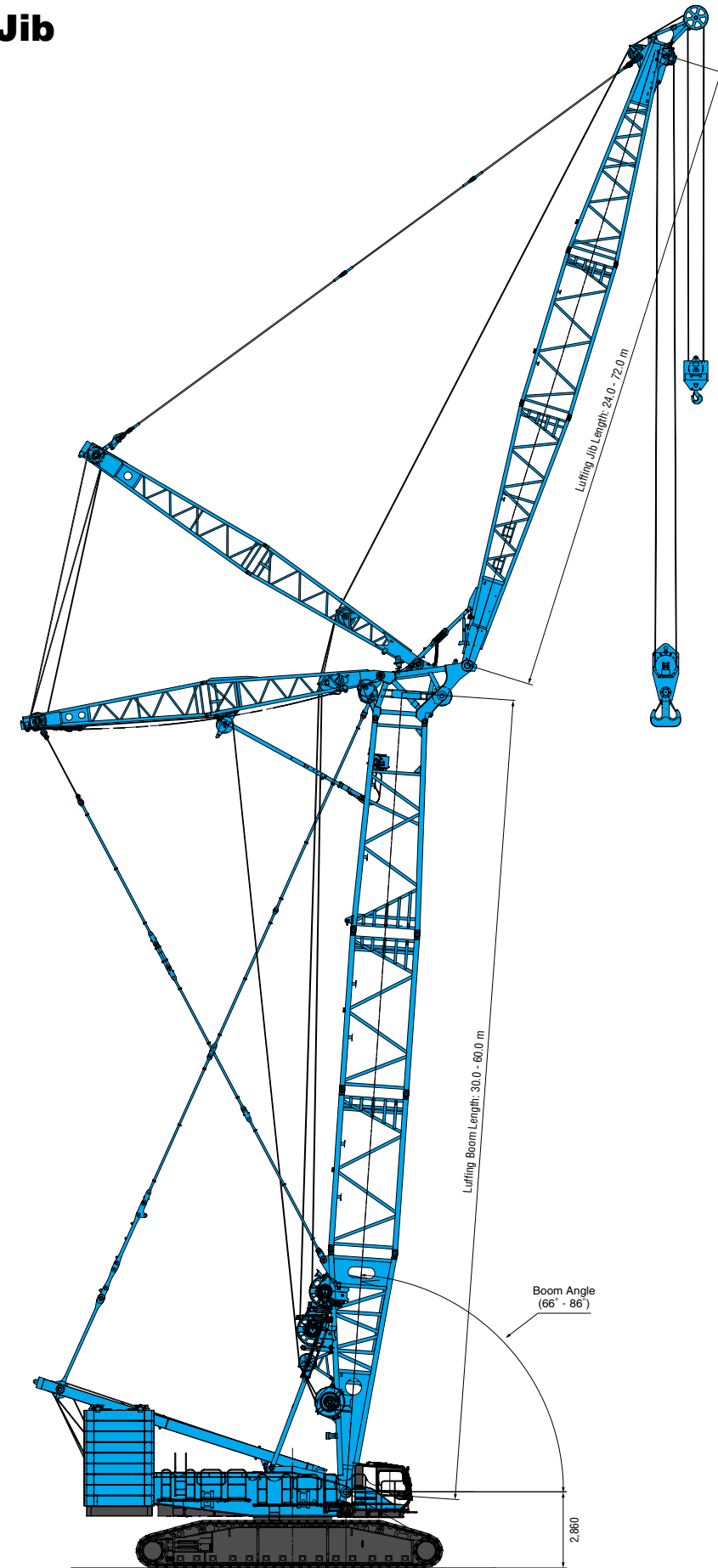

Unit: mm

Lift Enhancer

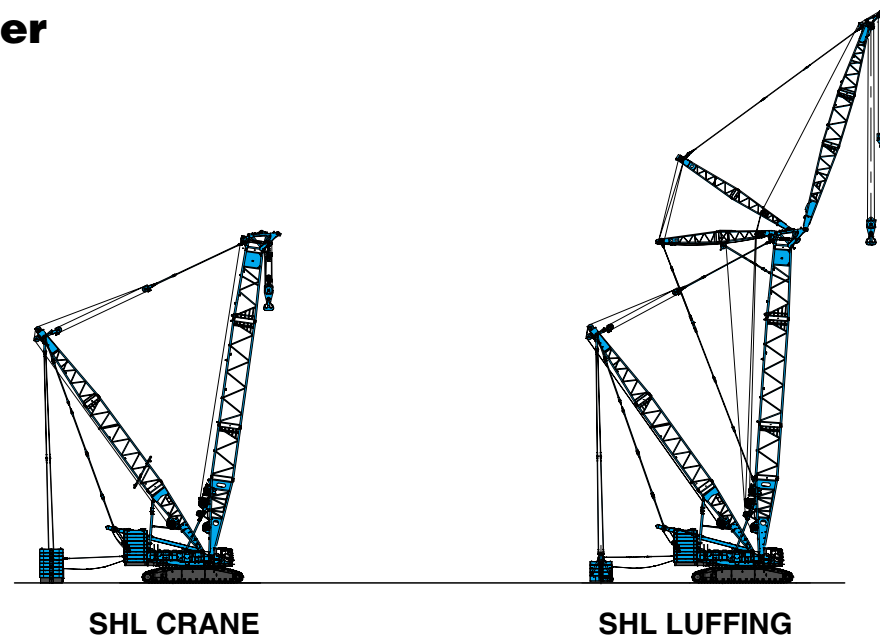

BOOM AND JIB ARRANGEMENTS

Heavy Duty Crane Boom Arrangements

Boom length m (ft)	Boom arrangement
24 (79)	
30 (98)	※
36 (117)	※
42 (138)	※
48 (157)	※
54 (177)	※
60 (197)	※
66 (217)	※
72 (236)	※
78 (256)	※
84 (276)	※

Symbol	Boom Length	Remarks
	9.0 m (29.5 ft)	Boom Base
	8.0 m (26.2 ft)	Tapered Boom
	6.0 m (19.7 ft)	Insert Boom
	12.0 m (39.4 ft)	Insert Boom
	1.0 m (3.3 ft)	Boom Top

※ indicates the most flexible combination of insert heavy duty booms, which can be modified to form all shorter heavy duty boom arrangements.

Luffing Boom Arrangements for Crane

Boom length m (ft)	Boom arrangement
30 (98)	※
36 (118)	※
42 (138)	※
48 (157)	※
54 (177)	※
60 (197)	※
66 (217)	※
72 (236)	※
78 (256)	※
84 (276)	※

Symbol	Boom Length	Remarks
	9.0 m (29.5 ft)	Boom Base
	8.0 m (26.2 ft)	Tapered Boom
	6.0 m (19.7 ft)	Insert Boom
	12.0 m (39.4 ft)	Insert Boom
	1.0 m (3.3 ft)	Boom Top

※ indicates the most flexible combination of insert luffing booms, which can be modified to form all shorter luffing boom arrangements.

Long Boom Arrangements

Boom length m (ft)	Boom arrangement
90 (295)	
96 (315)	※
102 (335)	※
108 (354)	※

Symbol	Boom Length	Remarks
	9.0 m (29.5 ft)	Boom Base
	8.0 m (26.2 ft)	Tapered Boom
	6.0 m (19.7 ft)	Insert Boom
	12.0 m (39.4 ft)	Insert Boom
	5.0 m (16.4 ft)	Luffing Insert Jib
	6.0 m (19.7 ft)	Luffing Insert Jib
	12.0 m (39.4 ft)	Luffing Insert Jib
	8.0 m (26.2 ft)	Jib Top

※ indicates the most flexible combination of insert long booms, which can be modified to form all shorter long boom arrangements.

Heavy Fixed Jib Boom Arrangements

Boom length m (ft)	Boom arrangement
66 (217)	※
72 (236)	※
78 (256)	※

Symbol	Boom Length	Remarks
	9.0 m (29.5 ft)	Boom Base
	8.0 m (26.2 ft)	Tapered Boom
	6.0 m (19.7 ft)	Insert Boom
	12.0 m (39.4 ft)	Insert Boom
	1.0 m (3.3 ft)	Boom Top

↗ mark shows the guy line installing position when the fixed jib is used.
 ※ indicates the most flexible combination of insert luffing booms, which can be modified to form all shorter luffing boom arrangements.

Heavy Fixed Jib Arrangements

Jib length m (ft)	Jib arrangement
18 (59)	

Symbol	Jib Length	Remarks
	10.0 m (32.8 ft)	Jib Base
	8.0 m (26.2 ft)	Jib Top

Luffing Boom Arrangements for Luffing

Boom length m (ft)	Boom arrangement
30 (98)	※
36 (118)	※
42 (138)	※
48 (157)	※
54 (177)	※
60 (197)	※

Symbol	Boom Length	Remarks
	9.0 m (29.5 ft)	Boom Base
	8.0 m (26.2 ft)	Tapered Boom
	6.0 m (19.7 ft)	Insert Boom
	12.0 m (39.4 ft)	Insert Boom
	1.0 m (3.3 ft)	Boom Top

※ indicates the most flexible combination of insert luffing booms, which can be modified to form all shorter luffing boom arrangements.

Luffing Jib Arrangements

Jib length m (ft)	Jib arrangement
24 (79)	
30 (98)	※
36 (118)	※
42 (138)	※
48 (157)	※
54 (177)	※
60 (197)	※
66 (217)	※
72 (236)	※

Symbol	Jib Length	Remarks
	10.0 m (32.8 ft)	Jib Base
	6.0 m (19.7 ft)	Luffing Insert Jib
	12.0 m (39.4 ft)	Luffing Insert Jib
	8.0 m (26.2 ft)	Jib Top

※ indicates the most flexible combination of insert luffing jibs, which can be modified to form all shorter luffing jib arrangements.

WORKING RANGES

Heavy Duty Crane Boom

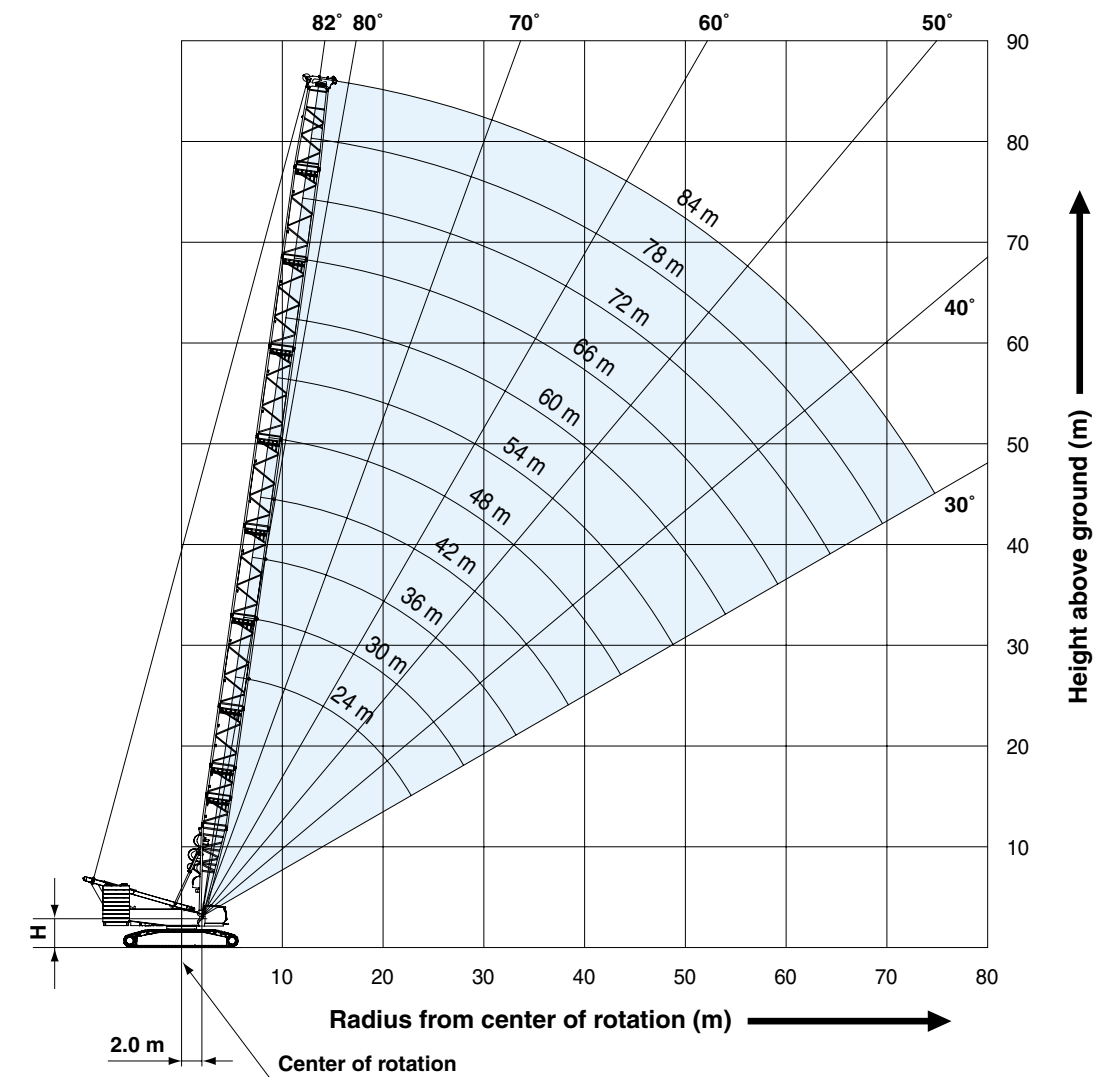

H=2.86 m Without quick connection ring
 H=3.08 m With quick connection ring

WORKING RANGES

Luffing Boom

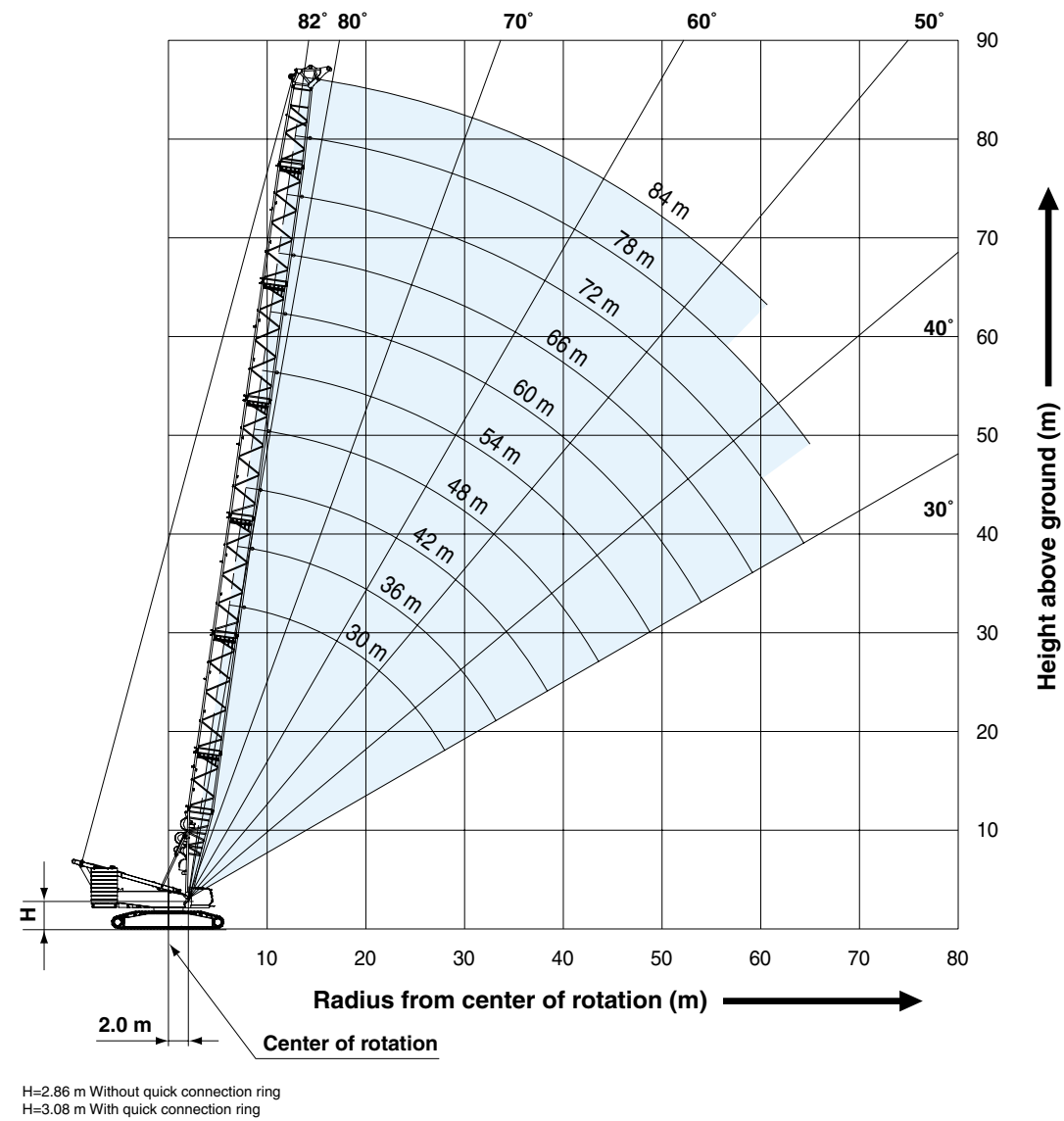

Long Boom

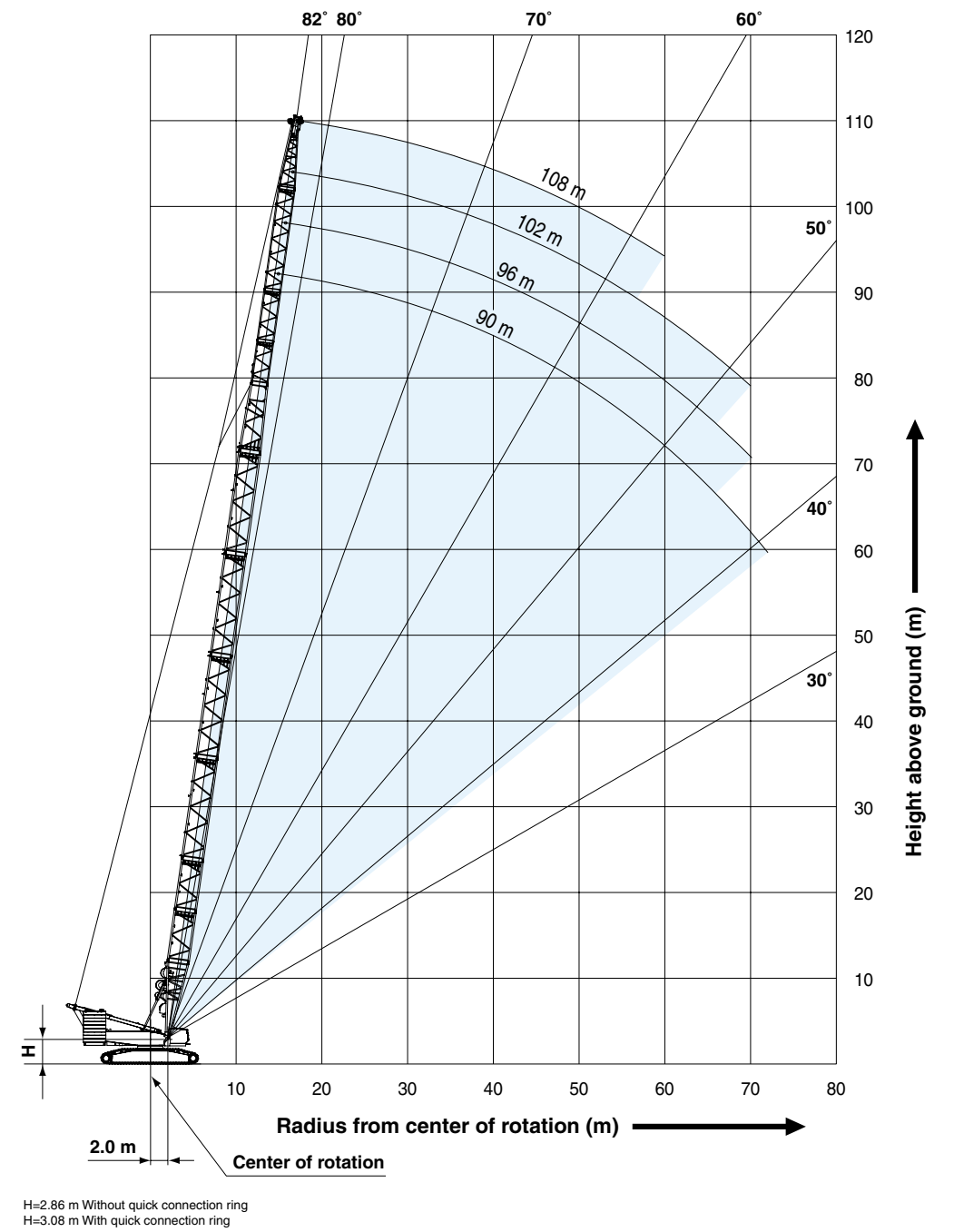

WORKING RANGES

Heavy Fixed Jib (Type A)

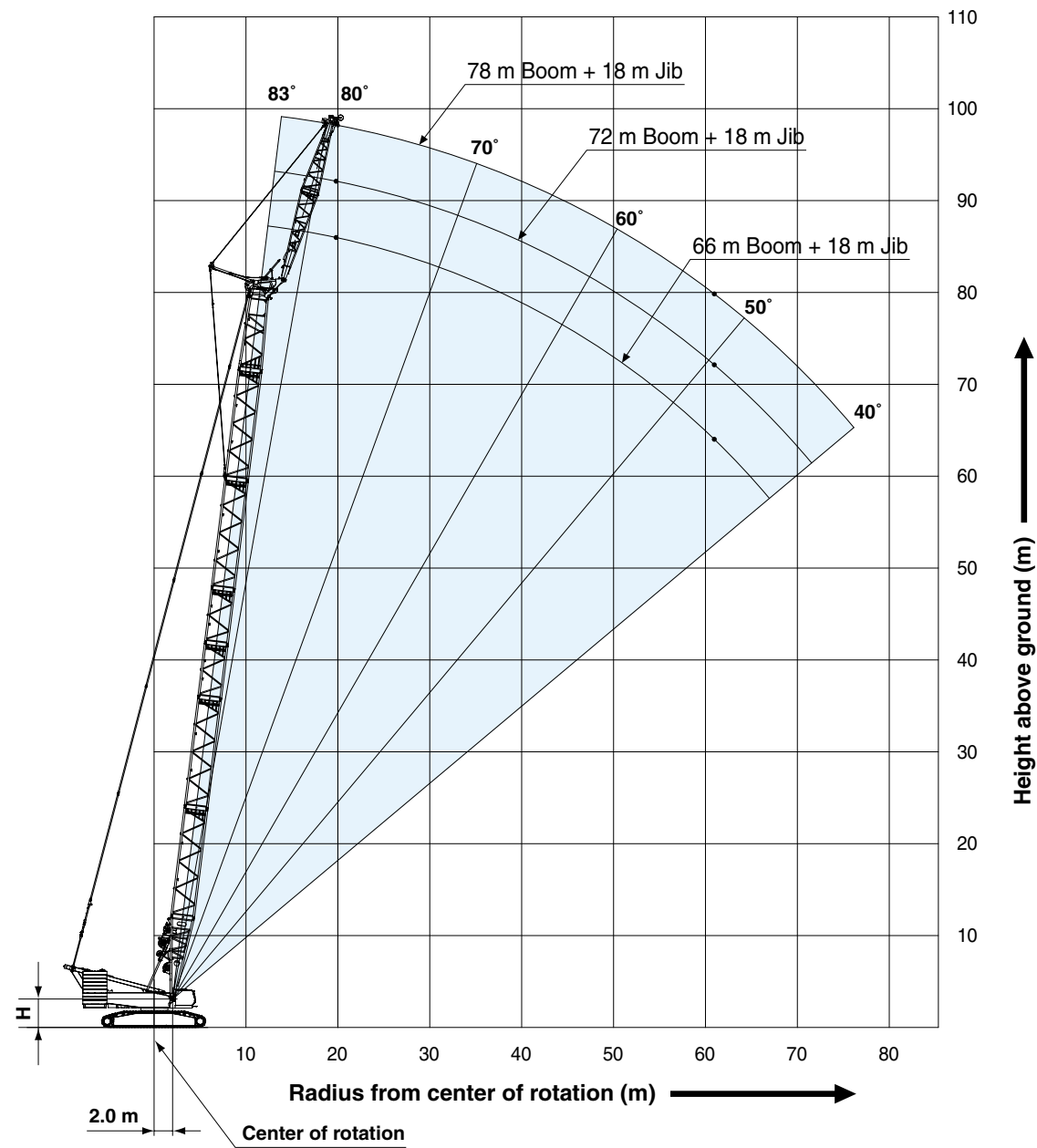

H=2.86 m Without quick connection ring
H=3.08 m With quick connection ring

Luffing Jib Boom Angle: 86°

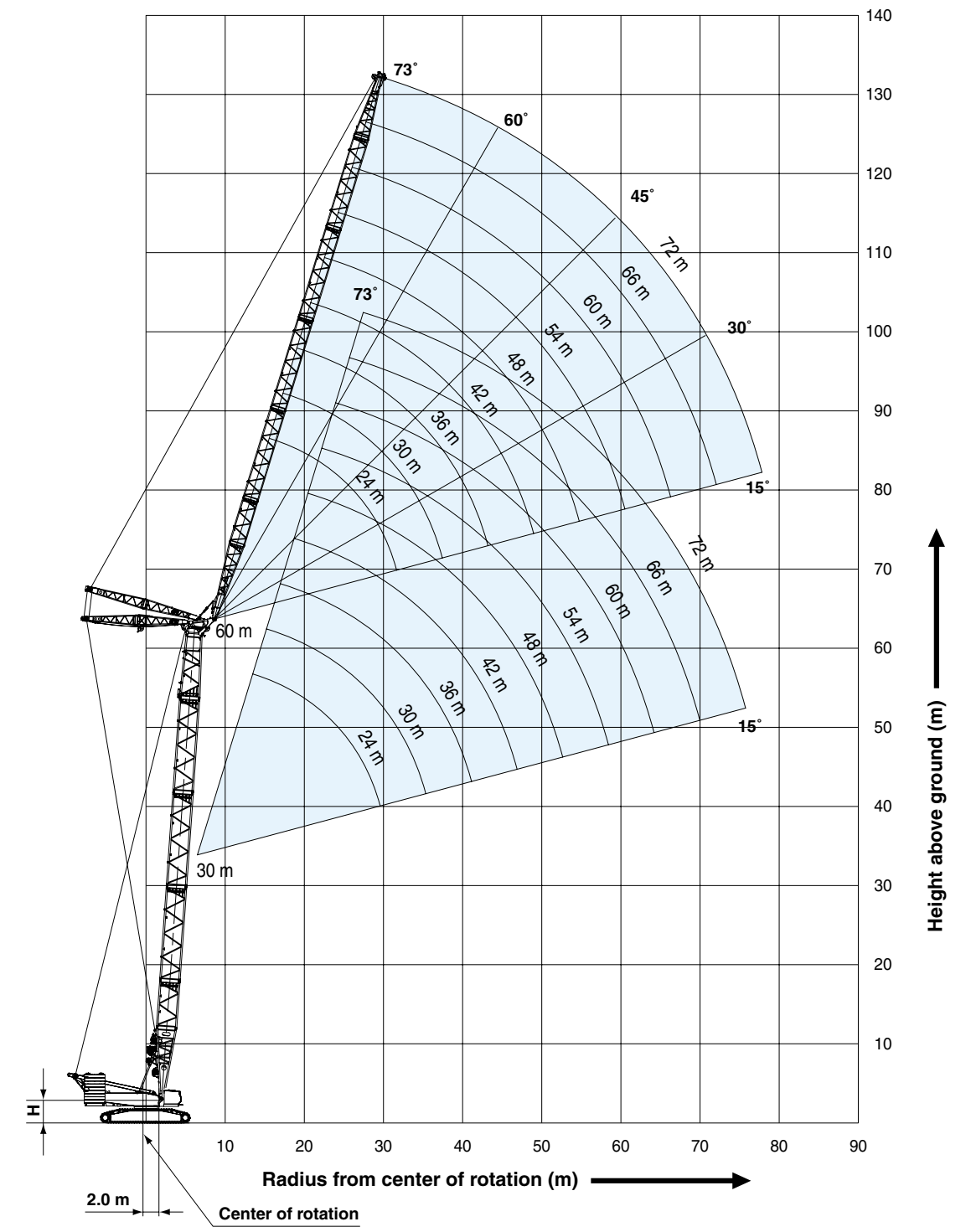

H=2.86 m Without quick connection ring
H=3.08 m With quick connection ring

WORKING RANGES

Luffing Jib

Boom Angle: 76°

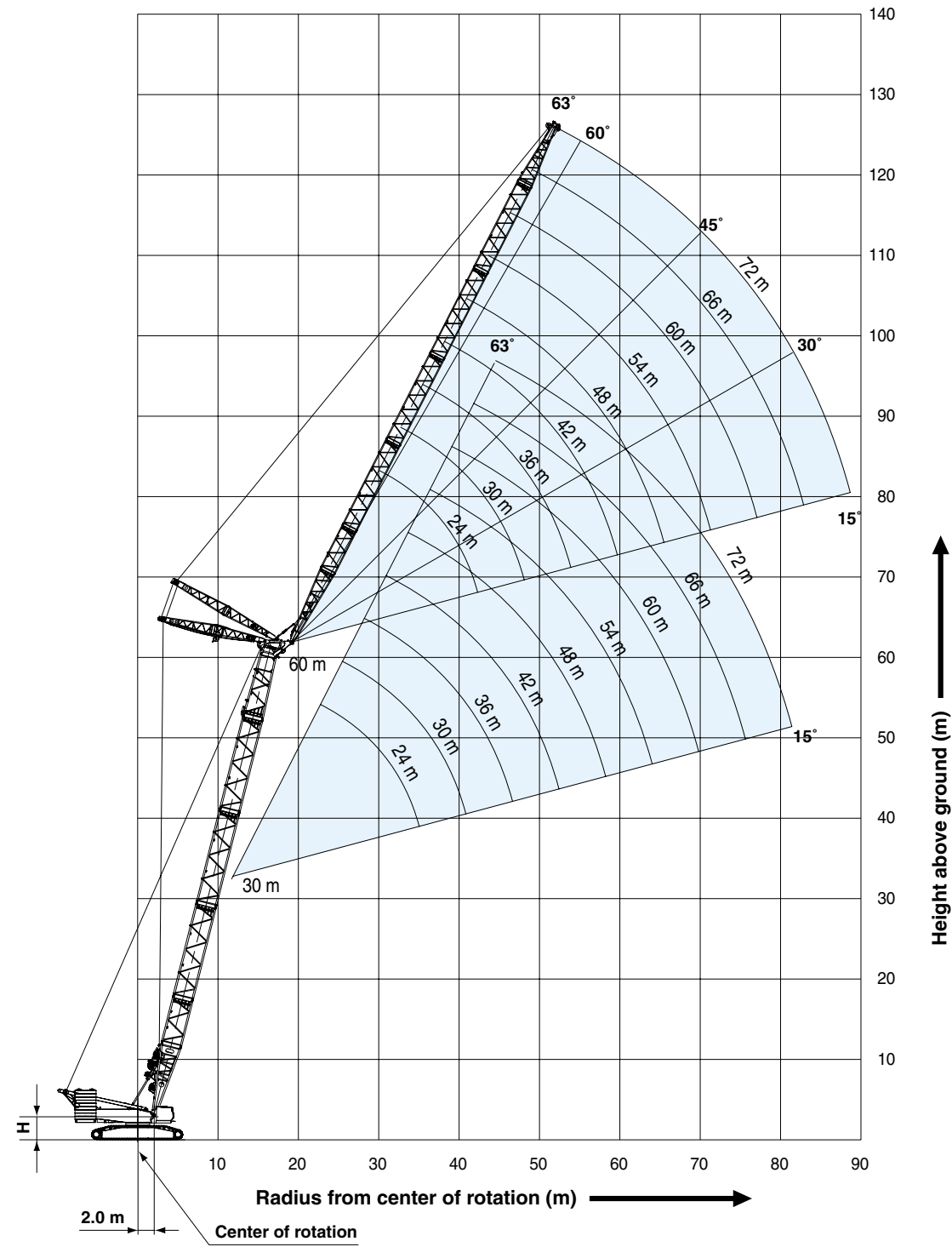

H=2.86 m Without quick connection ring
H=3.08 m With quick connection ring

Luffing Jib

Boom Angle: 66°

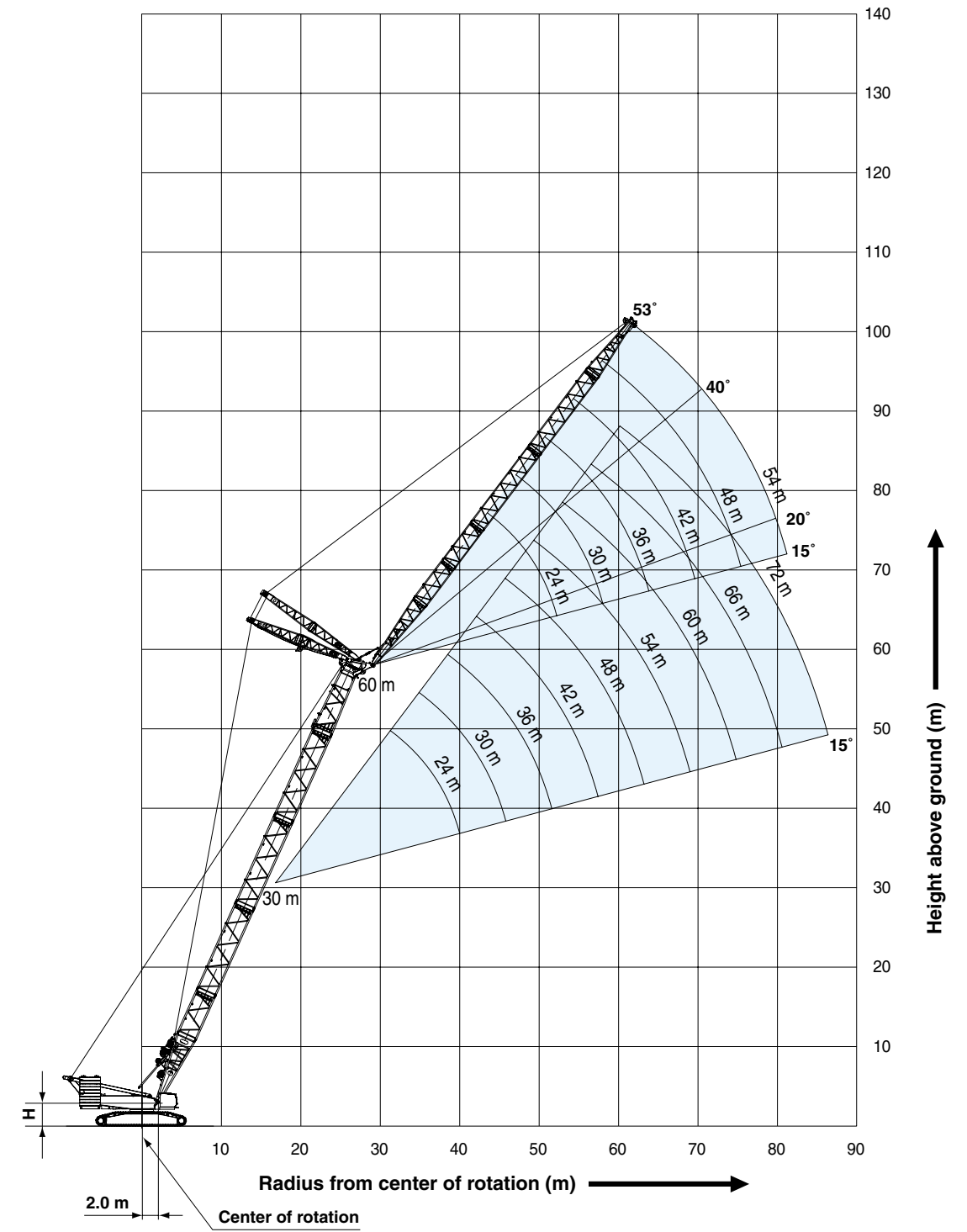

H=2.86 m Without quick connection ring
H=3.08 m With quick connection ring

CRANE BOOM SUPPLEMENTAL DATA

- Designed and rated to comply with EN13000.
- Operating radius is the horizontal distance from centerline of rotation to a vertical line through the center of gravity of the load.
- Deduct weight of hook block(s), slings and all other load handling accessories from main boom ratings shown.
- Ratings shown are based on freely suspended loads and make no allowance for such factors as wind effect on lifted load, ground conditions, out-of-level, operating speeds or any other condition that could be detrimental to the safe operation of this equipment. The operator, therefore, has the responsibility to judge the existing conditions and reduce lifted loads and operating speeds accordingly.
- Ratings are for operation on a firm and level surface, up to 1% gradient.
- At radii and boom lengths where no ratings are shown on chart, operation is not intended nor approved.
- Boom inserts, guy link and guy lines must be arranged as shown in the "OPERATOR'S MANUAL".
- Boom hoist reeving is 30 part line. HL/SHL boom hoist reeving is 18 part line.
- Boom backstops are required for all boom lengths.
- The boom should be erected over the front of the crawlers, not laterally.
- Ratings inside of boxes are limited by strength of materials.
- When erecting and lowering the boom length of 102 m or over, the blocks for erection must be placed at the end of the crawlers. (for STD MAST)
- When erecting and lowering the boom length of 108 m, the blocks for erection must be placed at the end of the crawlers. (for HL MAST)
- The minimum rated show below.

Minimum Rated Load		
Heavy Crane	STD Crane	Long Crane
12.1 ton	7.7 ton	6.2 ton

15. (Main Boom Lifting)

The total load that can be lifted is the value for weight of hook block, slings, and all other load handling accessories deducted from main boom ratings shown.

16. (Main Boom Lifting with Auxiliary Sheave Frame)

The total load that can be lifted is weight of auxiliary sheave frame, hook block(s), slings, and all other load handling accessories deducted from main boom ratings shown.

Deduction auxiliary sheave frame		
Heavy Crane	STD Crane	Long Crane
0.7 ton	0.7 ton	0.7 ton

17. (Auxiliary Sheave Lifting)

The total load that can be lifted is weight of auxiliary sheave frame, hook block(s), slings, and all other load handling accessories deducted from main boom ratings shown.

Deduction auxiliary sheave frame		
Heavy Crane	STD Crane	Long Crane
0.7 ton	0.7 ton	0.7 ton

- Ratings shown, but it should not exceed 14.0 ton in case of one reeve. and it should not exceed 28.0 ton in case of two reeves.
- Auxiliary sheave ratings at any radius from center of rotation are the same as crane ratings shown in table for main boom when operated at the same radius. But maximum angle is the same main boom maximum angle.
- Boom lengths for auxiliary sheave mounting show below.

	Mast for STD	Mast for HL	Mast for SHL
Heavy Crane	NONE	NONE	NONE

	Mast for STD	Mast for HL	Mast for SHL
STD Crane	30 m ~ 84 m	36 m ~ 84 m	36 m ~ 84 m

	Mast for STD	Mast for HL	Mast for SHL
Long Crane	90 m ~ 102 m	90 m ~ 108 m	90 m ~ 120 m

- Maximum hoist load for number of reeving parts of line for hoist rope.

Main Hoist Loads (Single Drum)

No. of Parts of Line	1	2	3	4	5
Maximum Loads (kN)	137	275	412	549	686
Maximum Loads (t)	14.0	28.0	42.0	56.0	70.0

No. of Parts of Line	6	7	8	9	10
Maximum Loads (kN)	824	961	1,098	1,236	1,373
Maximum Loads (t)	84.0	98.0	112.0	126.0	140.0

No. of Parts of Line	11	12	13	14	15
Maximum Loads (kN)	1,491	1,608	1,706	1,804	1,883
Maximum Loads (t)	152.0	164.0	174.0	184.0	192.0

No. of Parts of Line	16
Maximum Loads (kN)	1,961
Maximum Loads (t)	200.0

Main Hoist Loads for Heavy Boom (Double Drum)

No. of Parts of Line	8	12	16	20	24
Maximum Loads (kN)	1,098	1,608	2,157	2,746	3,295
Maximum Loads (t)	112.0	164.0	220.0	280.0	336.0

No. of Parts of Line	28	36	44
Maximum Loads (kN)	3,628	4,413	5,394
Maximum Loads (t)	370.0	450.0	550.0

Main Hoist Loads for STD Boom (Double Drum)

No. of Parts of Line	8	12	16	20	24
Maximum Loads (kN)	1,098	1,608	2,157	2,746	2,942
Maximum Loads (t)	112.0	164.0	220.0	280.0	300.0

Auxiliary Hoist Loads

No. of Parts of Line	1	2
Maximum Loads (kN)	137	275
Maximum Loads (t)	14.0	28.0

- Weight of hook block

Weight of hook block				
Hook block	550/450 ton	300 ton (with hanger sheave)	200 ton (w/o hanger sheave)	120 ton
Weight (t)	11.7	9.9 (*1)	7.1 (*2)	4.5

Weight of hook block			
Hook block	70 ton	40 ton	14 ton Ball hook
Weight (t)	3.1	2.0	0.9

*1: 7.82 ton: when hanger sheave is not equipped.

*2: To reeve 11 parts line or over hanger sheave (2 t) is not required.

- The rated load of the work when the strut guy line is installed on the boom upper surface is value in the rated load chart minus the value in the table below.

Heavy crane, STD crane					
Boom length(m)	24	30	36	42	48
Subtract load(t)	0.4	0.6	0.7	0.9	1.1

Heavy crane, STD crane					
Boom length(m)	54	60	66	72	78
Subtract load(t)	1.2	1.4	1.6	1.7	1.9

Heavy crane, STD crane	
Boom length(m)	84
Subtract load(t)	2.1

Long crane					
Boom length(m)	90	96	102	108	114
Subtract load(t)	1.7	1.7	1.9	1.9	2.1

Long crane		
Boom length(m)	120	126
Subtract load(t)	2.1	2.1

Operation of this equipment in excess of rated loads or disregard of instruction voids the warranty.

- Designed and rated to comply with EN13000.
- Operating radius is the horizontal distance from centerline of rotation to a vertical line through the center of gravity of the load.
- Deduct weight of hook block(s), slings and all other load handling accessories from luffing jib ratings shown.
- Ratings shown are based on freely suspended loads and make no allowance for such factors as wind effect on lifted load, ground conditions, out-of-level, operating speeds or any other condition that could be detrimental to the safe operation of this equipment. The operator, therefore, has the responsibility to judge the existing conditions and reduce lifted loads and operating speeds accordingly.
- Ratings are for operation on a firm and level surface, up to 1 % gradient.
- At radii and boom lengths where no ratings are shown on chart, operation is not intended nor approved.
- Boom and jib inserts and guy lines must be arranged as shown in the "OPERATOR'S MANUAL".
- Boom hoist reeving is 30 part line. HL/SHL boom hoist reeving is 18 part line. Jib hoist reeving is 18 part line.
- Boom and jib backstops are required for all boom lengths.
- The boom should be erected over the front of the crawlers, not laterally.

17. Luffing boom and jib combinations.

		Jib Length										
		24 m (79 ft)	30 m (98 ft)	36 m (118 ft)	42 m (138 ft)	48 m (157 ft)	54 m (177 ft)	60 m (197 ft)	66 m (217 ft)	72 m (236 ft)	78 m (256 ft)	84 m (276 ft)
Boom Length	30 m (98 ft)	○*	○*	○*	○*	○*	○*	○*	○*	○*	×	×
	36 m (118 ft)	○	○	○	○	○	○	○	○	○	○**	○**
	42 m (138 ft)	○	○	○	○	○	○	○	○	○	○**	○**
	48 m (157 ft)	○	○	○	○	○	○	○	○	○	○**	○**
	54 m (177 ft)	○	○	○	○	○	○	○	○	○	○**	○**
	60 m (197 ft)	○	○	○	○	○	○	○	○	○	○**	○**
	66 m (217 ft)	○***	○***	○***	○***	○***	○***	○***	○***	○***	○**	○**
	72 m (236 ft)	○**	○**	○**	○**	○**	○**	○**	○**	○**	○**	○**
	78 m (256 ft)	×	○**	○**	○**	○**	○**	○**	○**	○**	○**	○**
	84 m (276 ft)	×	○**	○**	○**	○**	○**	○**	○**	○**	○**	○**

- × : All luffing jib combinations which is not allowed.
- : All luffing jib combinations which is allowed.
- * : STD luffing jib combinations which is allowed.
- ** : SHL luffing jib combinations which is allowed.
- *** : HL and SHL luffing jib combinations which is allowed.

- Ratings inside of boxes are limited by strength of materials.
- When erecting and lowering the boom length of 54m or over, the blocks for erection must be placed at the end of the crawlers. (for STD MAST)
- The minimum rated load is 4.0 ton.
- (Luffing Jib Rating Loads)**
The total load that can be lifted is the value for weight of hook block, slings, and all other load handling accessories deducted from luffing jib ratings shown.
- (Luffing Jib Lifting with Auxiliary Sheave Frame)**
The total load that can be lifted is weight of hook block, slings, and all other load handling accessories deducted from luffing jib ratings shown.
- (Auxiliary Sheave Lifting)**
The total load that can be lifted over an auxiliary sheave is weight of hook block, slings, and all other load handling accessories deducted from luffing jib ratings shown, but it should not exceed 14.0 ton in case of one reeve. It should not exceed 28.0 ton in case of two reeves. Boom and jib combinations for auxiliary sheave mounting are all boom and jib combinations. Auxiliary sheave ratings at any radius from center of rotation are the same as luffing ratings shown in table for jib when operated at the same radius. But maximum angle is the same jib maximum angle.

- Maximum hoist load for number of reeving parts of line for hoist rope.

For Jib Hook (Single Drum)

No. of Parts of Line	1	2	3	4	5
Maximum Loads (kN)	137	275	412	549	686
Maximum Loads (t)	14.0	28.0	42.0	56.0	70.0

No. of Parts of Line	6	7	8	9	10
Maximum Loads (kN)	824	961	1,098	1,236	1,373
Maximum Loads (t)	84.0	98.0	112.0	126.0	140.0

No. of Parts of Line	11	12	13	14	15
Maximum Loads (kN)	1,491	1,608	1,706	1,804	1,883
Maximum Loads (t)	152.0	164.0	174.0	184.0	192.0

No. of Parts of Line	16
Maximum Loads (kN)	1,961
Maximum Loads (t)	200.0

For Jib Hook (Double Drum)

No. of Parts of Line	8	12	16
Maximum Loads (kN)	1,098	1,608	1,961
Maximum Loads (t)	112.0	164.0	200.0

For Auxiliary Sheave

No. of Parts of Line	1	2
Maximum Loads (kN)	137	275
Maximum Loads (t)	14.0	28.0

Weight of hook block					
Hook block	200 ton	120 ton	70 ton	40 ton	14 ton Ball Hook
Weight (t)	7.1	4.5	3.1	2.0	0.9

- Maximum number of reeving parts of line for hoist rope.

STD Luffing Jib (For Double Drum)

		Jib Length (m)									
		24	30	36	42	48	54	60	66	72	
Boom Length (m)	30	16	12	12	8	8	8	8	8	8	
	36	16	12	12	8	8	8	8	8	8	
	42	16	12	12	8	8	8	8	8	8	
	48	12	12	12	8	8	8	8	8	8	
	54	12	12	12	8	8	8	8	8	8	
	60	12	12	12	8	8	8	8	8	8	

HL Luffing Jib (For Double Drum)

		Jib Length (m)									
		24	30	36	42	48	54	60	66	72	
Boom Length (m)	36	16	16	12	12	12	8	8	8	8	
	42	16	16	12	12	12	8	8	8	8	
	48	16	16	12	12	12	8	8	8	8	
	54	16	12	12	12	8	8	8	8	8	
	60	12	12	12	12	8	8	8	8	8	
	66	12	12	12	8	8	8	8	8	8	

SHL Luffing Jib (For Double Drum)

		Jib Length (m)										
		24	30	36	42	48	54	60	66	72	78	84
Boom Length (m)	36	16	16	12	12	12	8	8	8	8	8	8
	42	16	16	12	12	12	8	8	8	8	8	8
	48	16	16	12	12	12	8	8	8	8	8	8
	54	16	16	12	12	12	8	8	8	8	8	8
	60	16	12	12	12	8	8	8	8	8	8	8
	66	12	12	12	8	8	8	8	8	8	8	8
	72	12	12	12	8	8	8	8	8	8	8	8
	78	X	12	8	8	8	8	8	8	8	8	8
	84	X	8	8	8	8	8	8	8	8	8	X

X : Combinations which is not allowed.

STD Luffing Jib (For Single Drum)

		Jib Length (m)								
		24	30	36	42	48	54	60	66	72
Boom Length (m)	30	13	11	10	8	8	7	7	6	5
	36	11	10	9	8	8	7	7	6	5
	42	10	9	9	8	7	7	6	6	5
	48	9	9	8	7	7	6	6	6	5
	54	9	8	7	7	6	6	6	5	5
	60	8	7	7	6	6	6	5	5	4

HL Luffing Jib (For Single Drum)

		Jib Length (m)								
		24	30	36	42	48	54	60	66	72
Boom Length (m)	36	11	10	9	9	8	7	7	6	5
	42	10	9	9	8	7	7	6	6	5
	48	9	9	8	7	7	6	6	6	5
	54	9	8	7	7	6	6	6	5	5
	60	8	7	7	6	6	6	5	5	5
	66	7	7	6	6	6	5	5	5	4

SHL Luffing Jib (For Single Drum)

		Jib Length (m)										
		24	30	36	42	48	54	60	66	72	78	84
Boom Length (m)	36	11	10	9	9	8	7	7	6	6	4	4
	42	10	9	9	8	7	7	6	6	5	4	4
	48	9	9	8	7	7	6	6	6	5	4	4
	54	9	8	7	7	6	6	6	5	5	4	4
	60	8	7	7	6	6	6	5	5	5	4	4
	66	7	7	6	6	6	5	5	5	4	4	3
	72	7	6	6	5	5	5	4	4	4	4	3
	78	X	6	5	5	5	5	4	4	4	3	3
	84	X	5	5	5	5	4	4	4	3	3	3

X : Combinations which is not allowed.

- Lifting capacities listed apply only to the machine as originally manufactured and designed by KOBELCO CRANES CO.,LTD. Modifications to this machine or use of equipment other than that specified can reduce operating capacity.

Operation of this equipment in excess of rated loads or disregard of instruction voids the warranty.



LIFTING CAPACITIES

Heavy Duty Crane Boom Lifting Capacities

Unit: ton

Counterweight: 200.0 ton, Carbody weight: 50.0 ton

Working Radius (m)	Boom Length (m)											Working Radius (m)
	24.0	30.0	36.0	42.0	48.0	54.0	60.0	66.0	72.0	78.0	84.0	
6.0	6.7 m/450.0											6.0
7.0	447.1	7.5 m/417.3										7.0
8.0	391.2	391.2	8.3 m/370.0									8.0
9.0	347.7	347.7	347.7	9.2 m/333.8								9.0
10.0	307.0	307.0	306.0	305.0	10.0 m/291.6	10.9 m/254.8	11.7 m/224.8					10.0
12.0	246.0	246.8	246.0	245.0	240.4	230.0	220.4	12.5 m/198.6	13.4 m/176.4			12.0
14.0	201.5	202.5	202.5	201.7	200.5	193.6	186.2	179.1	172.3	14.2 m/157.1	15.0 m/139.7	14.0
16.0	169.5	170.7	170.7	169.9	168.7	166.5	160.5	154.7	149.2	143.7	136.8	16.0
18.0	144.4	144.2	144.3	144.0	143.1	142.9	140.5	135.5	130.9	126.2	121.8	18.0
20.0	124.0	123.8	123.9	123.4	122.6	122.3	121.2	120.1	116.1	112.0	108.1	20.0
22.0	22.0 m/108.3	108.0	108.0	107.5	106.6	106.3	105.2	104.9	103.8	100.2	96.8	22.0
24.0		95.5	95.4	94.9	93.9	93.6	92.5	92.1	91.1	90.0	87.1	24.0
26.0		85.3	85.1	84.5	83.6	83.2	82.1	81.7	80.7	79.5	78.9	26.0
28.0		76.8	76.6	76.0	75.0	74.6	73.4	73.0	72.0	70.8	70.6	28.0
30.0		28.6 m/74.6	69.4	68.7	67.7	67.3	66.1	65.7	64.6	63.5	63.2	30.0
32.0			63.3	62.6	61.5	61.0	59.9	59.4	58.4	57.2	56.9	32.0
34.0			33.8 m/58.5	57.3	56.2	55.7	54.5	54.0	52.9	51.7	51.4	34.0
36.0				52.6	51.5	51.0	49.8	49.2	48.2	47.0	46.6	36.0
38.0				48.6	47.5	46.9	45.7	45.1	44.0	42.8	42.4	38.0
40.0				39.0 m/46.8	43.9	43.2	42.0	41.4	40.3	39.1	38.7	40.0
44.0					37.8	37.1	35.8	35.1	34.1	32.8	32.4	44.0
48.0					44.2 m/37.6	32.1	30.8	30.1	29.0	27.7	27.2	48.0
52.0						49.4 m/30.6	26.7	25.9	24.8	23.5	23.0	52.0
56.0							54.6 m/24.5	22.4	21.3	19.6	18.8	56.0
60.0								59.8 m/19.3	18.0	16.1	60.0 m/15.2	60.0
64.0									15.0	64.0 m/13.1		64.0
68.0										65.0 m/14.4		68.0
Reeves	36	36	28	24	24	20	20	16	16	12	12	Reeves

Note:
Designed and rated to comply with EN13000.
Ratings shown in [] are determined by the strength of the boom or other structural components.
Lifting capacities may vary depending on hook used or with / without auxiliary sheave.
Please refer rated chart in operator's cabin.

Heavy Fixed Jib (Type A) Lifting Capacities

Unit: ton

Counterweight: 200.0 ton, Carbody weight: 50.0 ton

Working Radius (m)	Jib Length (m)			Working Radius (m)
	66.0	72.0	78.0	
20.0	105.0	100.0	95.0	20.0
22.0	98.1	94.7	91.2	22.0
24.0	88.1	85.0	81.9	24.0
26.0	79.6	76.7	73.8	26.0
28.0	71.1	69.5	66.8	28.0
30.0	63.6	62.3	60.6	30.0
34.0	51.5	50.1	48.6	34.0
38.0	42.0	40.6	39.1	38.0
42.0	34.4	33.0	31.5	42.0
46.0	28.2	26.8	25.3	46.0
50.0	23.1	21.7	20.1	50.0
54.0	18.7	17.3	15.7	54.0
58.0	14.9	13.5	11.9	58.0
62.0	11.6	10.3	8.7	62.0
Reeves	8	8	8	Reeves

Note:
Designed and rated to comply with EN13000.
Ratings shown in [] are determined by the strength of the boom or other structural components.
Lifting capacities may vary depending on hook used or with / without auxiliary sheave.
Please refer rated chart in operator's cabin.

Long Boom Lifting Capacities

Unit: ton

Counterweight: 200.0 ton, Carbody weight: 50.0 ton

Working Radius (m)	Jib Length (m)				Working Radius (m)
	90.0	96.0	102.0	108.0	
14.0	15.0 m/98.0	15.8 m/84.0			14.0
16.0	98.0	84.0	16.6 m/70.0	17.5 m/70.0	16.0
18.0	98.0	84.0	70.0	70.0	18.0
20.0	96.5	84.0	70.0	70.0	20.0
22.0	87.7	84.0	70.0	70.0	22.0
24.0	80.4	80.4	70.0	70.0	24.0
26.0	74.2	74.2	70.0	70.0	26.0
28.0	68.9	68.9	68.0	62.5	28.0
30.0	62.6	64.3	62.3	55.9	30.0
32.0	56.7	59.7	57.2	50.3	32.0
34.0	51.5	54.9	52.7	45.3	34.0
36.0	46.9	50.1	48.6	41.0	36.0
38.0	42.8	45.9	45.0	37.1	38.0
40.0	39.1	42.1	41.3	33.6	40.0
44.0	32.8	35.7	34.6	27.6	44.0
48.0	27.6	30.5	29.1	22.7	48.0
52.0	23.1	26.0	24.5	18.6	52.0
56.0	19.3	22.0	20.5	15.0	56.0
60.0	16.0	18.5	17.1	60.0 m/11.9	60.0
64.0	13.1	15.5	14.1		64.0
68.0	10.4	12.9	11.4		68.0
72.0	72.0 m/8.1	70.0 m/11.7	70.0 m/10.2		72.0
Reeves	7	6	5	5	Reeves

Note:
Designed and rated to comply with EN13000.
Ratings shown in [] are determined by the strength of the boom or other structural components.
Lifting capacities may vary depending on hook used or with / without auxiliary sheave.
Please refer rated chart in operator's cabin.

Luffing Boom Lifting Capacities

Unit: ton

Counterweight: 200.0 ton, Carbody weight: 50.0 ton

Working Radius (m)	Boom Length (m)											Working Radius (m)
	30.0	36.0	42.0	48.0	54.0	60.0	66.0	72.0	78.0	84.0		
7.0	7.7 m/300.0											7.0
8.0	300.0	8.5 m/300.0										8.0
9.0	300.0	300.0	9.3 m/300.0									9.0
10.0	300.0	300.0	300.0	10.2 m/280.0	11.0 m/248.5	11.8 m/220.0						10.0
12.0	244.1	243.6	242.7	238.1	227.8	218.2	12.7 m/196.6	13.5 m/164.0				12.0
14.0	200.6	200.0	199.2	198.3	191.3	184.0	176.8	164.0	14.3 m/155.5	15.2 m/138.6		14.0
16.0	168.9	168.7	167.8	166.9	164.2	158.2	152.4	146.9	141.5	136.3		16.0
18.0	143.1	142.7	142.0	141.8	141.0	138.1	133.2	128.6	124.0	119.6		18.0
20.0	122.7	122.3	121.5	121.2	120.4	120.0	117.8	113.8	109.7	105.9		20.0
22.0	106.9	106.4	105.6	105.2	104.4	104.0	103.0	101.5	97.9	94.5		22.0
24.0	94.3	93.8	93.0	92.5	91.7	91.2	90.2	90.0	88.0	84.8		24.0
26.0	84.0	83.5	82.6	82.2	81.3	80.8	79.8	79.5	78.5	76.6		26.0
28.0	75.4	74.9	74.1	73.5	72.6	72.1	71.1	70.8	69.7	68.7		28.0
30.0	28.7 m/72.8	67.7	66.8	66.3	65.4	64.8	63.7	63.5	62.4	61.3		30.0
32.0		61.6	60.7	60.1	59.1	58.6	57.5	57.2	56.1	55.0		32.0
34.0		33.9 m/56.6	55.3	54.7	53.7	53.2	52.1	51.7	50.6	49.5		34.0
36.0			50.7	50.0	49.1	48.4	47.3	47.0	45.8	44.7		36.0
38.0			46.7	45.9	44.9	44.3	43.2	42.8	41.6	40.5		38.0
40.0			39.1 m/44.7	42.3	41.3	40.6	39.5	39.1	37.9	36.8		40.0
44.0				36.2	35.1	34.4	33.2	32.8	31.6	30.4		44.0
48.0				44.3 m/35.8	30.2	29.3	28.1	27.6	26.5	25.3		48.0
52.0					49.5 m/28.6	25.2	24.0	23.4	22.0	20.4		52.0
56.0						54.7 m/22.4	20.3	19.4	17.8	16.1		56.0
60.0							59.9 m/16.5	15.8	14.2	12.5		60.0
64.0								12.5	11.1	62.0 m/11.0		64.0
68.0									65.1 m/11.7	66.0 m/9.8		68.0
Reeves	24	24	24	20	20	16	16	12	12	12	12	Reeves

Note:
Designed and rated to comply with EN13000.
Ratings shown in [] are determined by the strength of the boom or other structural components.
This is rated for double drum.
Lifting capacities may vary depending on hook used or with / without auxiliary sheave.
Please refer rated chart in operator's cabin.
Ratings enclosed in gray color box in the table require double-drum specifications.

BOOM AND JIB ARRANGEMENTS

Heavy Duty Crane Boom Arrangements

Boom length m (ft)	Boom arrangement
36 (118)	※
42 (138)	※
48 (157)	※
54 (177)	※
60 (197)	※
66 (217)	※
72 (236)	※
78 (256)	※
84 (276)	※

Symbol	Boom Length	Remarks
	9.0 m (29.5 ft)	Boom Base
	8.0 m (26.2 ft)	Tapered Boom
	6.0 m (19.7 ft)	Insert Boom
	12.0 m (39.4 ft)	Insert Boom
	1.0 m (3.3 ft)	Boom Top

※ indicates the most flexible combination of insert heavy duty booms, which can be modified to form all shorter heavy duty boom arrangements.

Long Boom Arrangements

Boom length m (ft)	Boom arrangement
90 (295)	
96 (315)	※
102 (335)	※
108 (354)	※

Symbol	Boom Length	Remarks
	9.0 m (29.5 ft)	Boom Base
	8.0 m (26.2 ft)	Tapered Boom
	6.0 m (19.7 ft)	Insert Boom
	12.0 m (39.4 ft)	Insert Boom
	5.0 m (16.4 ft)	Luffing Insert Jib
	6.0 m (19.7 ft)	Luffing Insert Jib
	12.0 m (39.4 ft)	Luffing Insert Jib
	8.0 m (26.2 ft)	Jib Top

※ indicates the most flexible combination of insert long booms, which can be modified to form all shorter long boom arrangements.

Luffing Boom Arrangements for Crane

Boom length m (ft)	Boom arrangement
36 (118)	※
42 (138)	※
48 (157)	※
54 (177)	※
60 (197)	※
66 (217)	※
72 (236)	※
78 (256)	※
84 (276)	※

Symbol	Boom Length	Remarks
	9.0 m (29.5 ft)	Boom Base
	8.0 m (26.2 ft)	Tapered Boom
	6.0 m (19.7 ft)	Insert Boom
	12.0 m (39.4 ft)	Insert Boom
	1.0 m (3.3 ft)	Boom Top

※ indicates the most flexible combination of insert luffing booms, which can be modified to form all shorter luffing boom arrangements.

Heavy Fixed Jib Boom Arrangements (Type B1)

Boom length m (ft)	Boom arrangement
66 (217)	※
72 (236)	※
78 (256)	※

Symbol	Boom Length	Remarks
	9.0 m (29.5 ft)	Boom Base
	8.0 m (26.2 ft)	Tapered Boom
	6.0 m (19.7 ft)	Insert Boom
	12.0 m (39.4 ft)	Insert Boom
	1.0 m (3.3 ft)	Boom Top

↗ mark shows the guy line installing position when the fixed jib is used.
※ indicates the most flexible combination of insert luffing booms, which can be modified to form all shorter luffing boom arrangements.

Heavy Fixed Jib Arrangements (Type B1)

Jib length m (ft)	Jib arrangement
18 (59)	

Symbol	Jib Length	Remarks
	10.0 m (32.8 ft)	Jib Base
	8.0 m (26.2 ft)	Jib Top

BOOM AND JIB ARRANGEMENTS

Luffing Boom Arrangements for Luffing

Boom length m (ft)	Boom arrangement
36 (118)	※ [L] 6.0 12.0 [8T] [LU]
42 (138)	※ [L] 6.0 12.0 6.0 [8T] [LU] [L] 12.0 12.0 [8T] [LU]
48 (157)	※ [L] 12.0 12.0 6.0 [8T] [LU]
54 (177)	※ [L] 6.0 6.0 12.0 12.0 [8T] [LU] [L] 12.0 12.0 12.0 [8T] [LU]
60 (197)	※ [L] 12.0 12.0 6.0 12.0 [8T] [LU]
66 (217)	※ [L] 6.0 6.0 12.0 12.0 12.0 [8T] [LU] [L] 12.0 12.0 12.0 12.0 [8T] [LU]

Symbol	Boom Length	Remarks
[L]	9.0 m (29.5 ft)	Boom Base
[8T]	8.0 m (26.2 ft)	Tapered Boom
[6.0]	6.0 m (19.7 ft)	Insert Boom
[12.0]	12.0 m (39.4 ft)	Insert Boom
[LU]	1.0 m (3.3 ft)	Boom Top

※ indicates the most flexible combination of insert luffing booms, which can be modified to form all shorter luffing boom arrangements.

Luffing Jib Arrangements

Jib length m (ft)	Jib arrangement
24 (79)	[L] 6.0 [U]
30 (98)	※ [L] 6.0 6.0 [U] [L] 12.0 [U]
36 (118)	※ [L] 6.0 12.0 [U]
42 (138)	※ [L] 6.0 6.0 12.0 [U] [L] 12.0 12.0 [U]
48 (157)	※ [L] 6.0 12.0 12.0 [U]
54 (177)	※ [L] 6.0 6.0 12.0 12.0 [U] [L] 12.0 12.0 12.0 [U]
60 (197)	※ [L] 6.0 12.0 12.0 12.0 [U]
66 (217)	※ [L] 6.0 6.0 12.0 12.0 12.0 [U] [L] 12.0 12.0 12.0 12.0 [U]
72 (236)	※ [L] 6.0 12.0 12.0 12.0 12.0 [U]

Symbol	Jib Length	Remarks
[L]	10.0 m (32.8 ft)	Jib Base
[6.0]	6.0 m (19.7 ft)	Luffing Insert Jib
[12.0]	12.0 m (39.4 ft)	Luffing Insert Jib
[U]	8.0 m (26.2 ft)	Jib Top

※ indicates the most flexible combination of insert luffing jibs, which can be modified to form all shorter luffing jib arrangements.

HL MAST

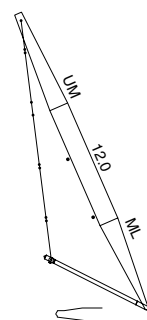

Symbol	Mast Length	Remarks
[ML]	9.0 m (29.5 ft)	Mast Base
[12.0]	12.0 m (39.4 ft)	Insert Mast
[UM]	9.0 m (29.5 ft)	Mast Top

WORKING RANGES

Heavy Duty Crane Boom

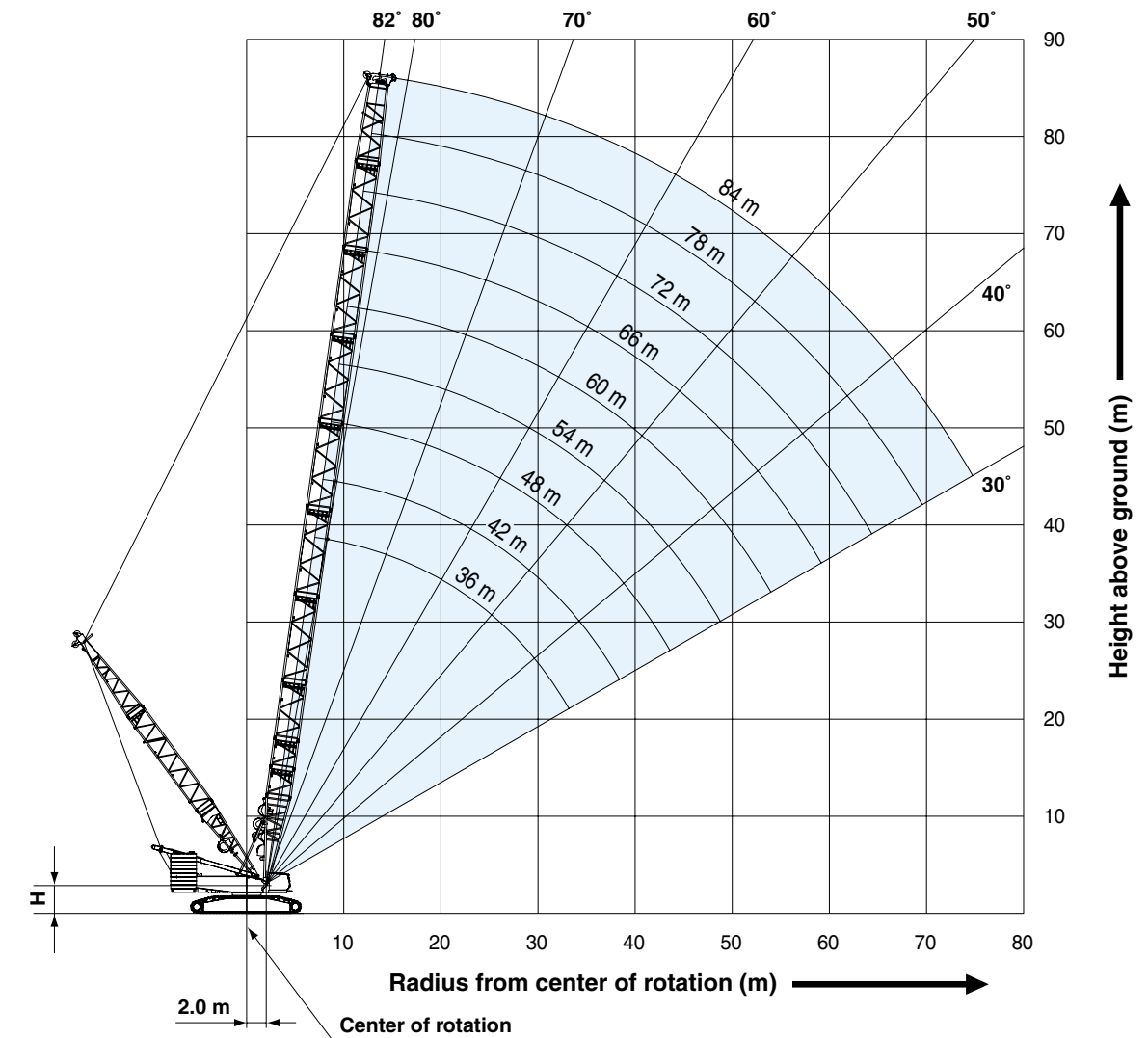

H=2.86 m Without quick connection ring
H=3.08 m With quick connection ring

WORKING RANGES

Luffing Boom

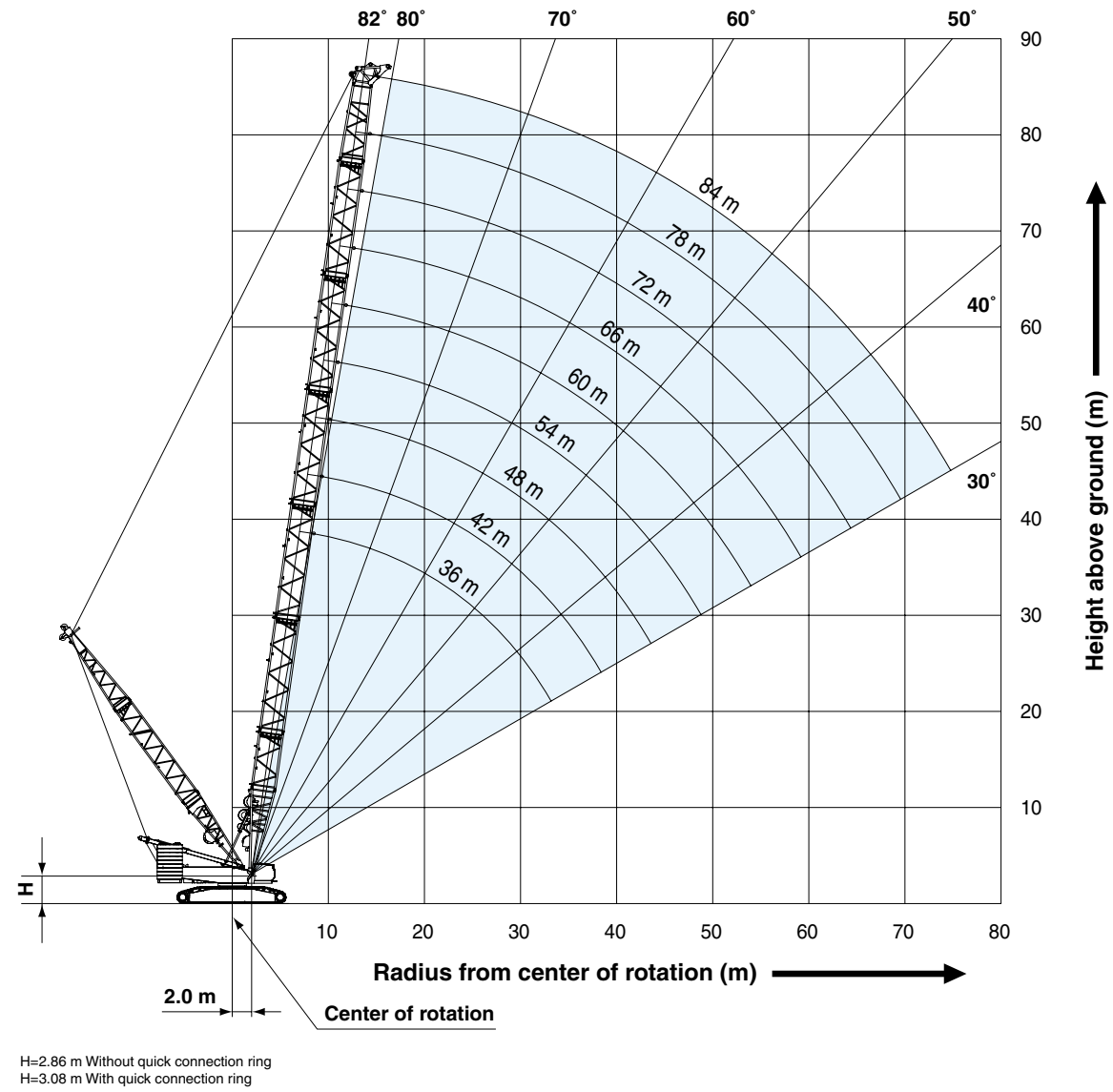

Long Boom

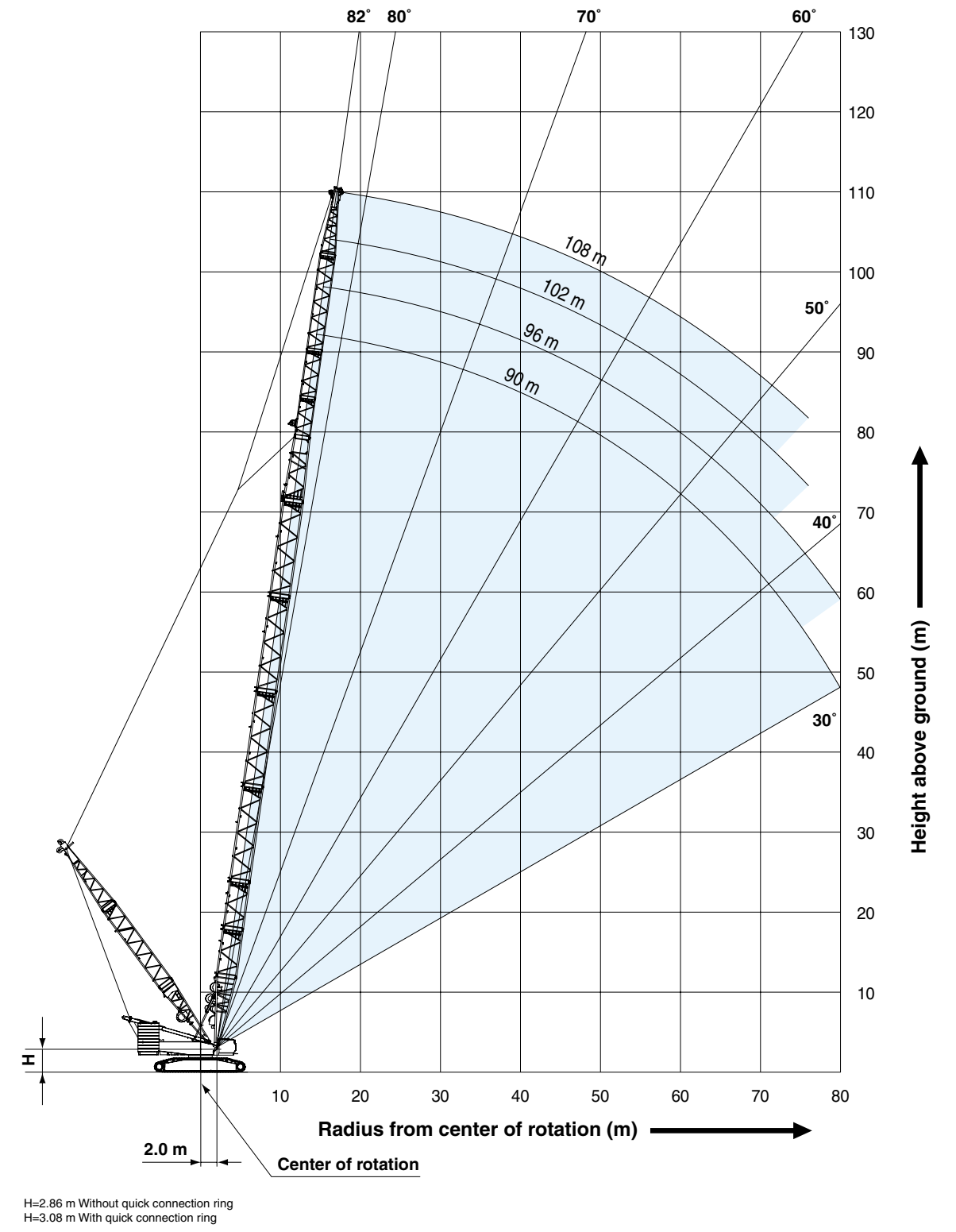

WORKING RANGES

Heavy Fixed Jib (Type B1)

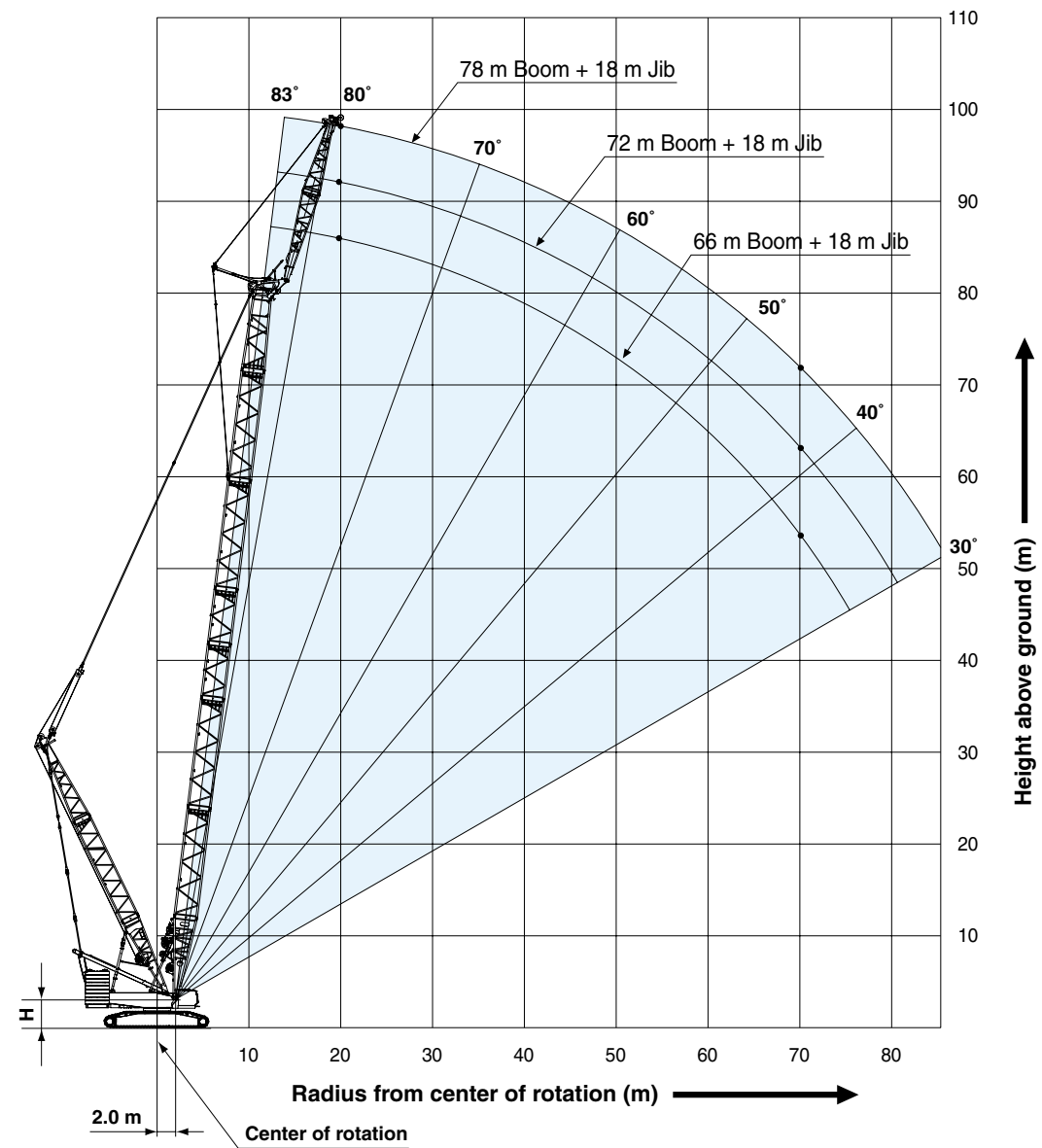

H=2.86 m Without quick connection ring
H=3.08 m With quick connection ring

Luffing Jib Boom Angle: 86°

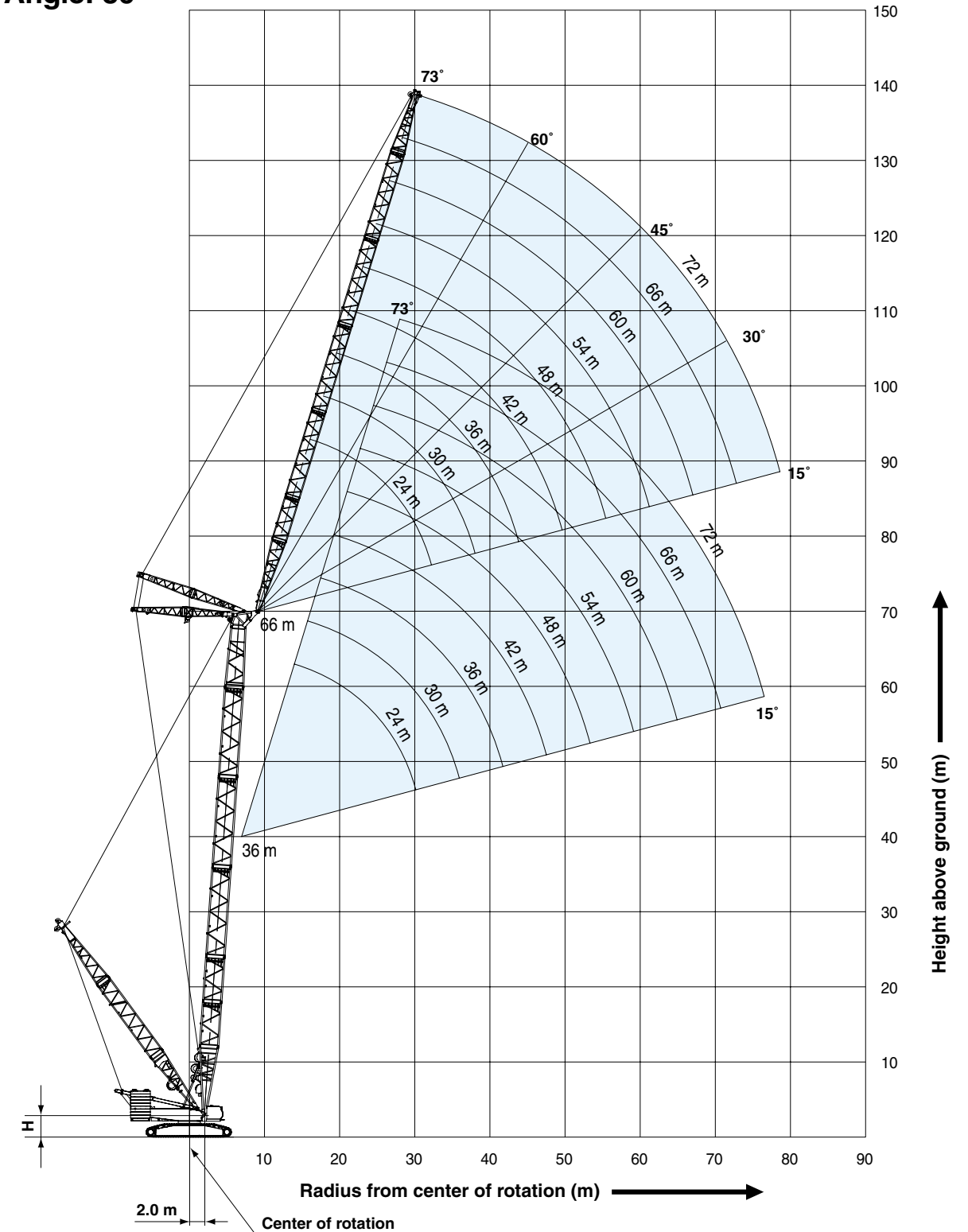

H=2.86 m Without quick connection ring
H=3.08 m With quick connection ring

WORKING RANGES

Luffing Jib

Boom Angle: 76°

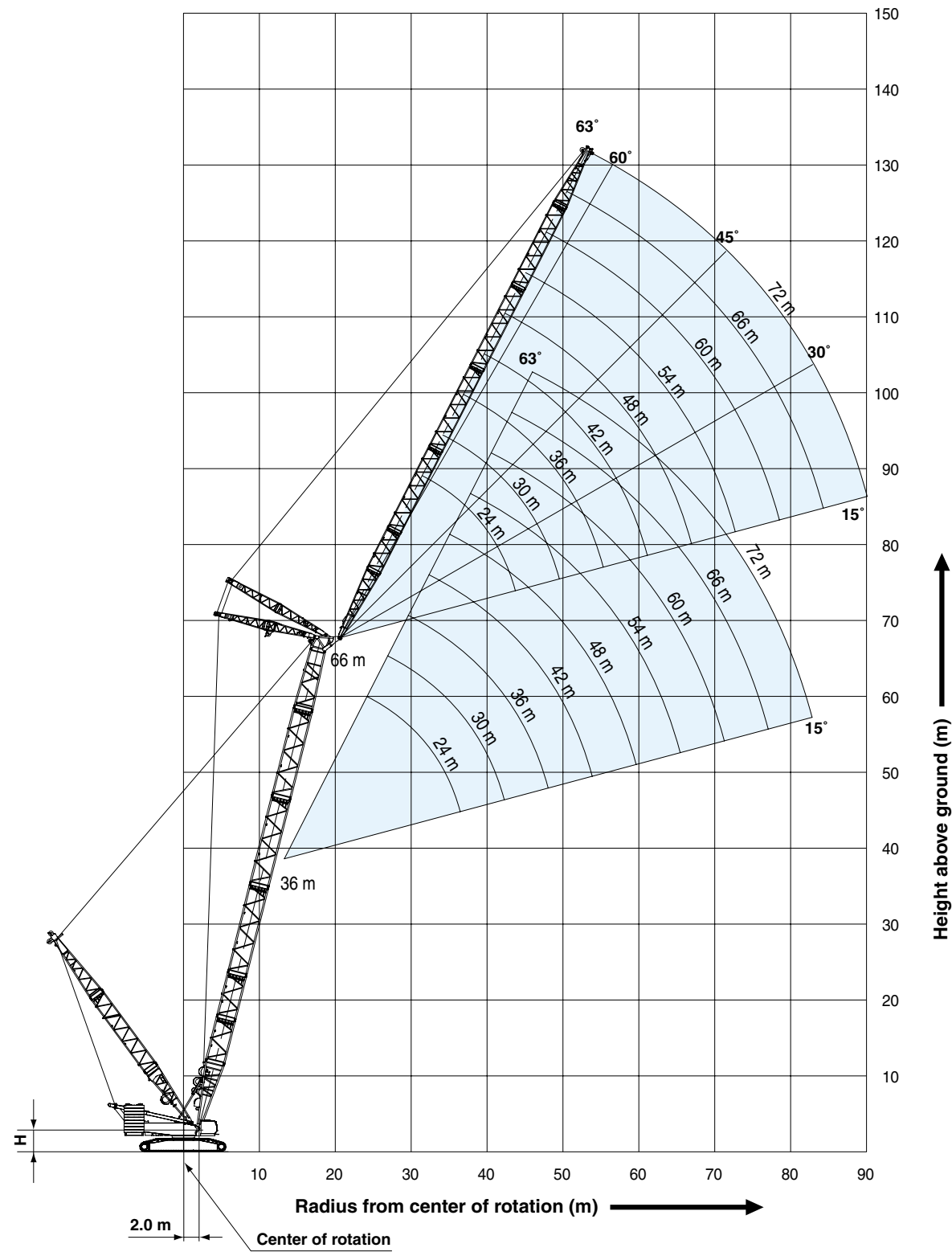

H=2.86 m Without quick connection ring
H=3.08 m With quick connection ring

Luffing Jib

Boom Angle: 66°

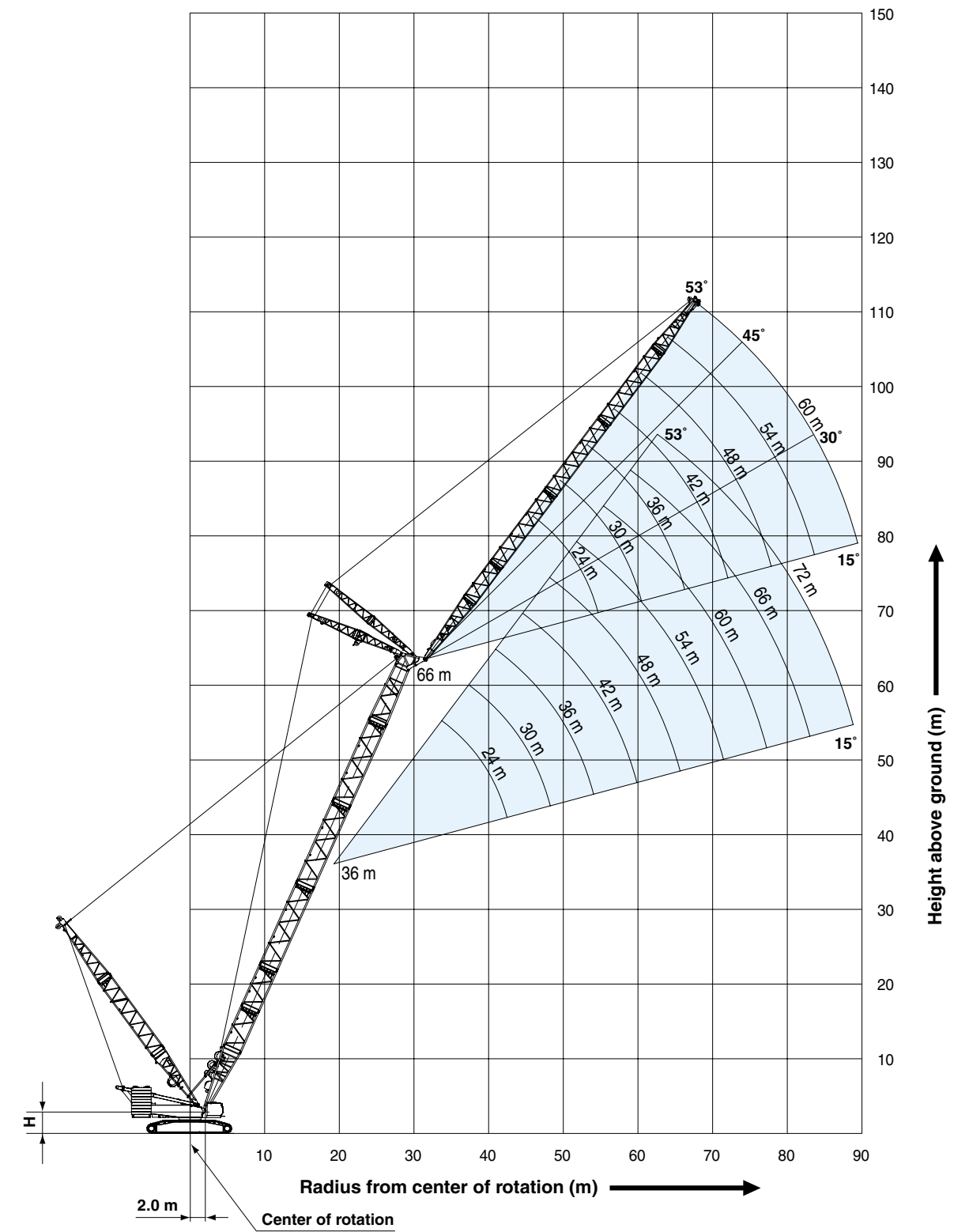

H=2.86 m Without quick connection ring
H=3.08 m With quick connection ring

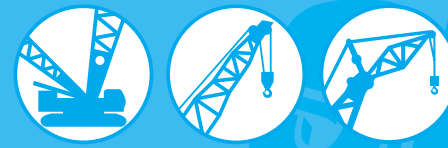
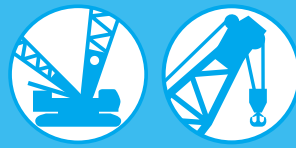

LIFTING CAPACITIES Heavy Duty Crane Boom Lifting Capacities

Unit: ton

Counterweight: 200.0 ton, Carbody weight: 50.0 ton
HL Mast point radius: 11 m to 16 m

Working Radius (m)	36.0		42.0		48.0		54.0		60.0		66.0		72.0		78.0		84.0		Working Radius (m)
	Boom Length (m)	Working Radius (m)	Boom Length (m)	Working Radius (m)	Boom Length (m)	Working Radius (m)	Boom Length (m)	Working Radius (m)	Boom Length (m)	Working Radius (m)	Boom Length (m)	Working Radius (m)	Boom Length (m)	Working Radius (m)	Boom Length (m)	Working Radius (m)	Boom Length (m)	Working Radius (m)	
8.0	8.3 m/370.0																		8.0
9.0	353.3	9.2 m/336.0																	9.0
10.0	308.5	309.1	10.0 m/309.5	10.9 m/276.1	11.7 m/251.2														10.0
12.0	243.3	243.6	243.7	243.5	243.0	12.5 m/220.0	13.4 m/201.2												12.0
14.0	199.8	199.9	199.8	199.5	198.9	198.1	192.1	14.2 m/182.3	15.0 m/164.0										14.0
16.0	168.8	168.7	168.5	168.1	167.4	166.5	165.7	160.8	155.2										16.0
18.0	145.5	145.3	145.0	144.5	143.7	142.9	142.0	141.0	136.8										18.0
20.0	127.4	127.1	126.8	126.2	125.4	124.5	123.6	122.6	121.5										20.0
22.0	112.9	112.6	112.2	111.6	110.7	109.8	108.9	107.8	106.7										22.0
24.0	101.1	100.7	100.2	99.6	98.7	97.7	96.8	95.8	94.6										24.0
26.0	91.2	90.7	90.3	89.6	88.7	87.7	86.8	85.7	84.6										26.0
28.0	82.8	82.3	81.9	81.2	80.2	79.2	78.3	77.2	76.0										28.0
30.0	75.6	75.1	74.6	73.9	73.0	72.0	71.0	69.9	68.7										30.0
32.0	69.4	68.9	68.4	67.7	66.7	65.7	64.7	63.6	62.4										32.0
34.0	33.8 m/64.4	63.4	62.9	62.2	61.2	60.2	59.2	58.1	56.9										34.0
36.0		58.6	58.1	57.4	56.4	55.3	54.3	53.2	52.0										36.0
38.0		54.3	53.8	53.0	52.1	51.0	50.0	48.9	47.7										38.0
40.0		39.0 m/52.3	49.9	49.2	48.2	47.1	46.1	45.0	43.8										40.0
44.0			43.3	42.6	41.6	40.5	39.5	38.4	37.2										44.0
48.0			44.2 m/43.0	37.1	36.1	35.0	34.0	32.9	31.7										48.0
52.0				49.4 m/35.4	31.5	30.4	29.4	28.3	27.1										52.0
56.0					54.6 m/28.9	26.5	25.5	24.4	23.1										56.0
60.0						59.8 m/23.3	22.1	21.0	19.8										60.0
64.0							19.2	18.0	16.8										64.0
68.0							65.0 m/18.5	15.4	68.0 m/14.2										68.0
72.0								70.2 m/14.1											72.0
Reeves	28	24	24	20	20	16	16	16	12										Reeves

Note: Designed and rated to comply with EN13000.

Ratings shown in [] are determined by the strength of the boom or other structural components.
Lifting capacities may vary depending on hook used or with / without auxiliary sheave.
Please refer rated chart in operator's cabin.
Please refer Page 21 for Crane Boom Supplemental Data.

Long Boom Lifting Capacities

Unit: ton

Counterweight: 200.0 ton, Carbody weight: 50.0 ton
HL Mast point radius: 11 m to 16 m

Working Radius (m)	90.0		96.0		102.0		108.0		Working Radius (m)
	Boom Length (m)	Working Radius (m)	Boom Length (m)	Working Radius (m)	Boom Length (m)	Working Radius (m)	Boom Length (m)	Working Radius (m)	
14.0	15.0 m/98.0	15.8 m/98.0							14.0
16.0	98.0	98.0	16.6 m/84.0	17.5 m/84.0					16.0
18.0	98.0	98.0	84.0	84.0					18.0
20.0	98.0	98.0	84.0	84.0					20.0
22.0	95.7	95.7	84.0	84.0					22.0
24.0	87.7	87.7	84.0	84.0					24.0
26.0	81.0	81.0	81.0	81.0					26.0
28.0	75.2	75.2	75.2	75.0					28.0
30.0	70.2	70.2	70.2	68.9					30.0
32.0	65.4	65.3	64.1	63.4					32.0
34.0	59.9	59.7	58.5	58.3					34.0
36.0	55.0	54.8	53.6	53.4					36.0
38.0	50.7	50.5	49.3	49.1					38.0
40.0	46.8	46.6	45.4	45.2					40.0
44.0	40.2	40.0	38.7	38.5					44.0
48.0	34.7	34.5	33.2	33.0					48.0
52.0	30.1	29.8	28.6	28.4					52.0
56.0	26.1	25.9	24.7	24.4					56.0
60.0	22.7	22.5	21.3	21.1					60.0
64.0	19.8	19.5	18.2	18.0					64.0
68.0	17.1	16.7	15.4	15.2					68.0
72.0	14.6	14.2	12.9	12.7					72.0
76.0	12.4	12.0	76.0 m/10.7	76.0 m/10.5					76.0
80.0	10.5	80.0 m/10.1							80.0
84.0	80.1 m/10.5								84.0
Reeves	7	7	6	6					Reeves

Note:

Designed and rated to comply with EN13000.

Ratings shown in [] are determined by the strength of the boom or other structural components.

Lifting capacities may vary depending on hook used or with / without auxiliary sheave.

Please refer rated chart in operator's cabin.

Please refer Page 21 for Crane Boom Supplemental Data.

Heavy Fixed Jib (Type B1) Lifting Capacities

Unit: ton

Counterweight: 200.0 ton, Carbody weight: 50.0 ton
HL Mast point radius: 11 m

Working Radius (m)	18.0			Working Radius (m)
	Boom Length (m)	Working Radius (m)	Boom Length (m)	
20.0	120.0	120.0	117.0	20.0
22.0	107.9	107.2	104.8	22.0
24.0	95.5	94.6	93.7	24.0
26.0	85.1	84.2	83.2	26.0
28.0	76.3	75.4	74.4	28.0
30.0	68.8	67.8	66.8	30.0
34.0	56.6	55.6	54.4	34.0
38.0	47.1	46.0	44.9	38.0
42.0	39.5	38.4	37.2	42.0
46.0	33.3	32.2	31.0	46.0
50.0	28.2	27.0	25.8	50.0
54.0	23.8	22.6	21.4	54.0
58.0	20.1	18.9	17.6	58.0
62.0	16.9	15.7	14.4	62.0
66.0	14.1	12.9	11.5	66.0
70.0	11.6	10.4	9.1	70.0
Reeves	10	10	10	Reeves

Note:

Designed and rated to comply with EN13000.

Ratings shown in [] are determined by the strength of the boom or other structural components.

Lifting capacities may vary depending on hook used or with / without auxiliary sheave.

Please refer rated chart in operator's cabin.

Ratings enclosed in gray-color box in the table require double-drum specifications.

Please refer Page 21 for Heavy Fixed Jib Supplemental Data.

BOOM AND JIB ARRANGEMENTS

Heavy Duty Crane Boom Arrangements

Boom length m (ft)	Boom arrangement
36 (118)	※ L 6.0 12.0 8T HU
42 (138)	※ L 6.0 6.0 12.0 8T HU L 12.0 12.0 8T HU
48 (157)	※ L 12.0 12.0 6.0 8T HU
54 (177)	※ L 6.0 6.0 12.0 12.0 8T HU L 12.0 12.0 12.0 8T HU
60 (197)	※ L 12.0 12.0 6.0 12.0 8T HU
66 (217)	※ L 6.0 6.0 12.0 12.0 12.0 8T HU L 12.0 12.0 12.0 12.0 8T HU
72 (236)	※ L 12.0 12.0 6.0 12.0 12.0 8T HU
78 (256)	※ L 6.0 6.0 12.0 12.0 12.0 12.0 8T HU L 12.0 12.0 12.0 12.0 12.0 8T HU
84 (276)	※ L 12.0 12.0 6.0 12.0 12.0 12.0 8T HU

Symbol	Boom Length	Remarks
L	9.0 m (29.5 ft)	Boom Base
8T	8.0 m (26.2 ft)	Tapered Boom
6.0	6.0 m (19.7 ft)	Insert Boom
12.0	12.0 m (39.4 ft)	Insert Boom
HU	1.0 m (3.3 ft)	Boom Top

※ indicates the most flexible combination of insert heavy duty booms, which can be modified to form all shorter heavy duty boom arrangements.

Long Boom Arrangements

Boom length m (ft)	Boom arrangement
90 (295)	L 12.0 12.0 6.0 12.0 12.0 8T 5LT 6.0L UL
96 (315)	※ L 12.0 12.0 6.0 12.0 12.0 8T 5LT 6.0L 6.0L UL L 12.0 12.0 6.0 12.0 12.0 8T 5LT 12.0L UL
102 (335)	※ L 6.0 6.0 12.0 12.0 12.0 12.0 8T 5LT 6.0L 6.0L UL L 12.0 12.0 12.0 12.0 12.0 8T 5LT 6.0L 6.0L UL L 6.0 6.0 12.0 12.0 12.0 12.0 8T 5LT 12.0L UL
108 (354)	※ L 6.0 6.0 12.0 12.0 12.0 12.0 8T 5LT 6.0L 12.0L UL L 12.0 12.0 12.0 12.0 12.0 8T 5LT 6.0L 12.0L UL
114 (374)	※ L 12.0 12.0 6.0 12.0 12.0 12.0 8T 5LT 6.0L 12.0L UL
120 (394)	※ L 12.0 12.0 6.0 12.0 12.0 12.0 8T 5LT 6.0L 6.0L 12.0L UL L 12.0 12.0 6.0 12.0 12.0 12.0 8T 5LT 12.0L 12.0L UL
126 (413)	※ L 12.0 12.0 6.0 12.0 12.0 12.0 8T 5LT 6.0L 12.0L 12.0L UL

Symbol	Boom Length	Remarks
L	9.0 m (29.5 ft)	Boom Base
8T	8.0 m (26.2 ft)	Tapered Boom
6.0	6.0 m (19.7 ft)	Insert Boom
12.0	12.0 m (39.4 ft)	Insert Boom
5LT	5.0 m (16.4 ft)	Luffing Insert Jib
6.0L	6.0 m (19.7 ft)	Luffing Insert Jib
12.0L	12.0 m (39.4 ft)	Luffing Insert Jib
UL	8.0 m (26.2 ft)	Luffing Top

※ indicates the most flexible combination of insert long booms, which can be modified to form all shorter long boom arrangements.

Luffing Boom Arrangements for Crane

Boom length m (ft)	Boom arrangement
36 (118)	※ L 6.0 12.0 8T LU
42 (138)	※ L 6.0 12.0 6.0 8T LU L 12.0 12.0 8T LU
48 (157)	※ L 12.0 12.0 6.0 8T LU
54 (177)	※ L 6.0 6.0 12.0 12.0 8T LU L 12.0 12.0 12.0 8T LU
60 (197)	※ L 12.0 12.0 6.0 12.0 8T LU
66 (217)	※ L 6.0 6.0 12.0 12.0 12.0 8T LU L 12.0 12.0 12.0 12.0 8T LU
72 (236)	※ L 12.0 12.0 6.0 12.0 12.0 8T LU
78 (256)	※ L 6.0 6.0 12.0 12.0 12.0 12.0 8T LU L 12.0 12.0 12.0 12.0 12.0 8T LU
84 (276)	※ L 12.0 12.0 6.0 12.0 12.0 12.0 8T LU

Symbol	Boom Length	Remarks
L	9.0 m (29.5 ft)	Boom Base
8T	8.0 m (26.2 ft)	Tapered Boom
6.0	6.0 m (19.7 ft)	Insert Boom
12.0	12.0 m (39.4 ft)	Insert Boom
LU	1.0 m (3.3 ft)	Boom Top

※ indicates the most flexible combination of insert luffing booms, which can be modified to form all shorter luffing boom arrangements.

BOOM AND JIB ARRANGEMENTS

Heavy Fixed Jib Boom Arrangements (Type B2)

Boom length m (ft)	Boom arrangement
66 (217)	※
72 (236)	※
78 (256)	※

Symbol	Boom Length	Remarks
	9.0 m (29.5 ft)	Boom Base
	8.0 m (26.2 ft)	Tapered Boom
	6.0 m (19.7 ft)	Insert Boom
	12.0 m (39.4 ft)	Insert Boom
	1.0 m (3.3 ft)	Boom Top

↗ mark shows the guy line installing position when the fixed jib is used.
 ※ indicates the most flexible combination of insert luffing booms, which can be modified to form all shorter luffing boom arrangements.

Heavy Fixed Jib Arrangements (Type B2)

Jib length m (ft)	Jib arrangement
18 (59)	

Symbol	Jib Length	Remarks
	10.0 m (32.8 ft)	Jib Base
	8.0 m (26.2 ft)	Jib Top

Luffing Boom Arrangements for Luffing

Boom length m (ft)	Boom arrangement
36 (118)	※
42 (138)	※
48 (157)	※
54 (177)	※
60 (197)	※
66 (217)	※
72 (236)	※
78 (256)	※
84 (276)	※

Symbol	Boom Length	Remarks
	9.0 m (29.5 ft)	Boom Base
	8.0 m (26.2 ft)	Tapered Boom
	6.0 m (19.7 ft)	Insert Boom
	12.0 m (39.4 ft)	Insert Boom
	1.0 m (3.3 ft)	Boom Top

※ indicates the most flexible combination of insert luffing booms, which can be modified to form all shorter luffing boom arrangements.

Heavy Fixed Jib Boom Arrangements (Type C)

Boom length m (ft)	Boom arrangement
84 (276)	※
90 (296)	※
96 (316)	※
102 (336)	※

Symbol	Boom Length	Remarks
	9.0 m (29.5 ft)	Boom Base
	8.0 m (26.2 ft)	Tapered Boom
	6.0 m (19.7 ft)	Insert Boom
	12.0 m (39.4 ft)	Insert Boom
	1.0 m (3.3 ft)	Boom Top

↗ mark shows the guy line installing position when the fixed jib is used.
 ※ indicates the most flexible combination of insert heavy duty booms, which can be modified to form all shorter heavy duty boom arrangements.

Luffing Jib Arrangements

Jib length m (ft)	Jib arrangement
24 (79)	
30 (98)	※
36 (118)	※
42 (136)	※
48 (157)	※
54 (177)	※
60 (197)	※
66 (217)	※
72 (236)	※
78 (256)	※
84 (276)	※

Symbol	Jib Length	Remarks
	10.0 m (32.8 ft)	Jib Base
	6.0 m (19.7 ft)	Luffing Insert Jib
	12.0 m (39.4 ft)	Luffing Insert Jib
	8.0 m (26.2 ft)	Jib Top

※ indicates the most flexible combination of insert luffing jibs, which can be modified to form all shorter luffing jib arrangements.

Heavy Fixed Jib Arrangements (Type C)

Jib length m (ft)	Jib arrangement
18 (59)	

Symbol	Jib Length	Remarks
	10.0 m (32.8 ft)	Jib Base
	8.0 m (26.2 ft)	Jib Top

SHL MAST

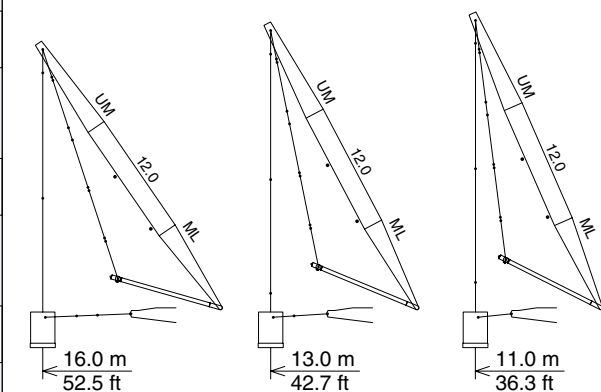

Symbol	Mast Length	Remarks
	9.0 m (29.5 ft)	Mast Base
	12.0 m (39.4 ft)	Insert Mast
	9.0 m (29.5 ft)	Mast Top

WORKING RANGES

Heavy Duty Crane Boom

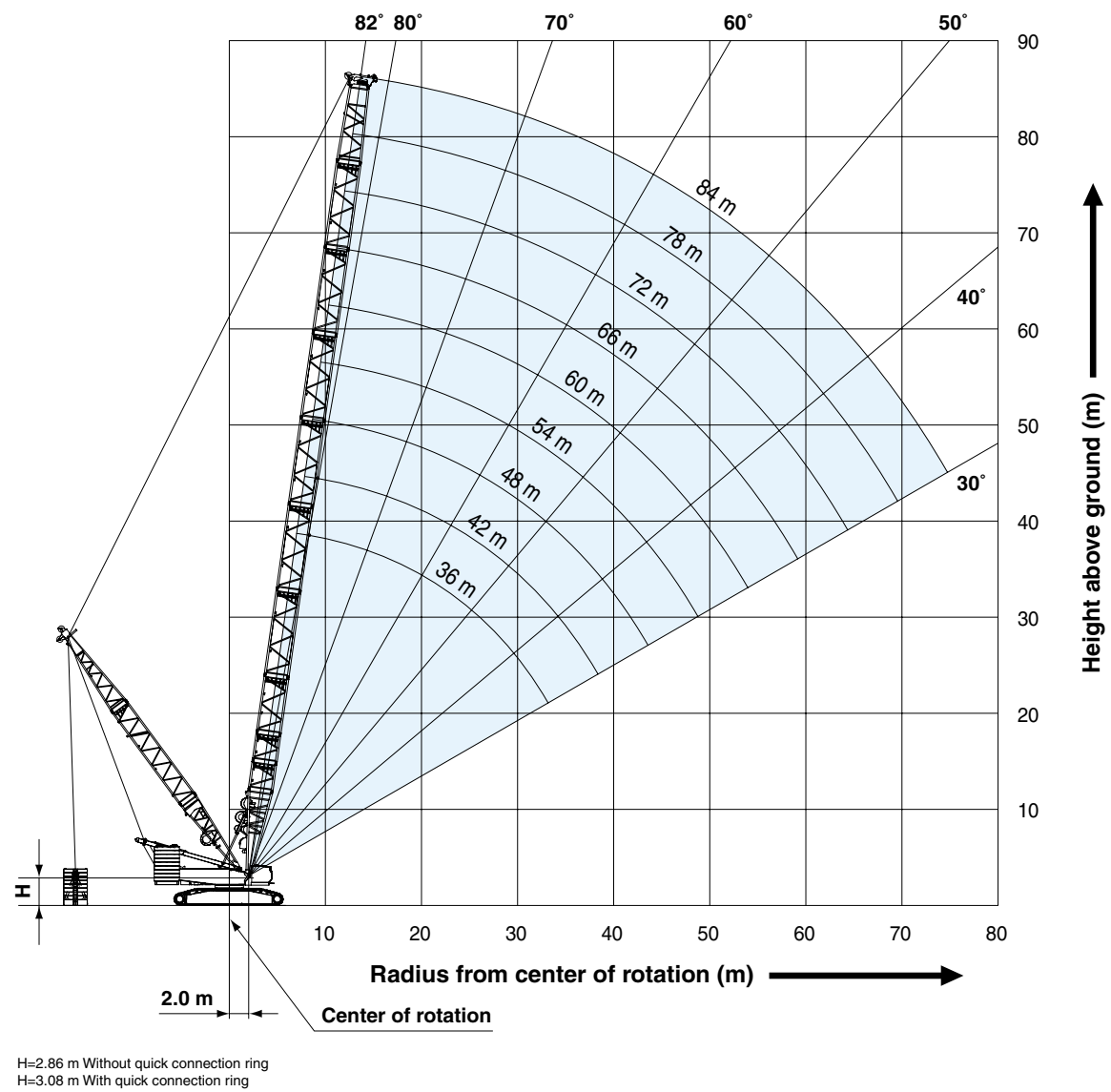

Luffing Boom

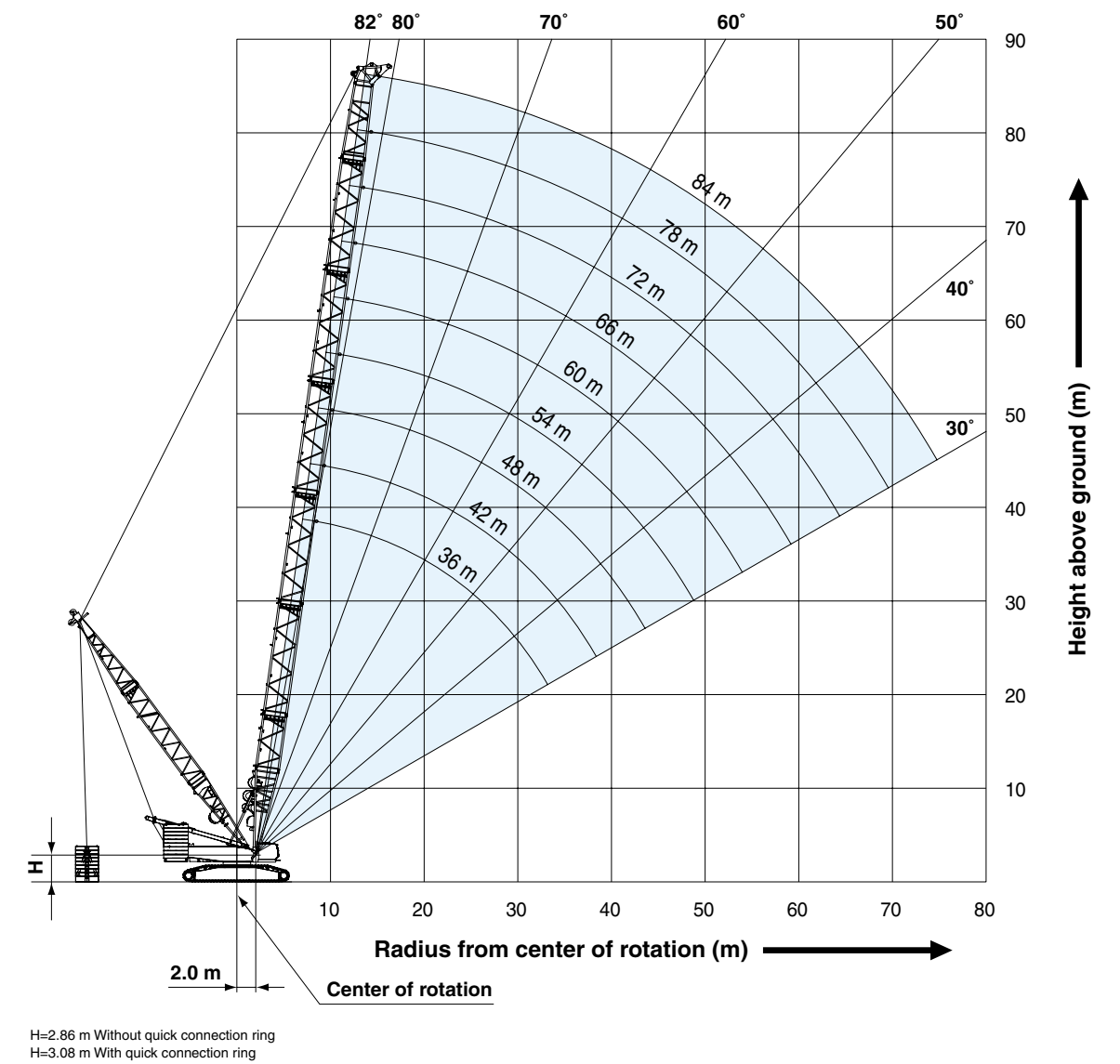

WORKING RANGES

Long Boom

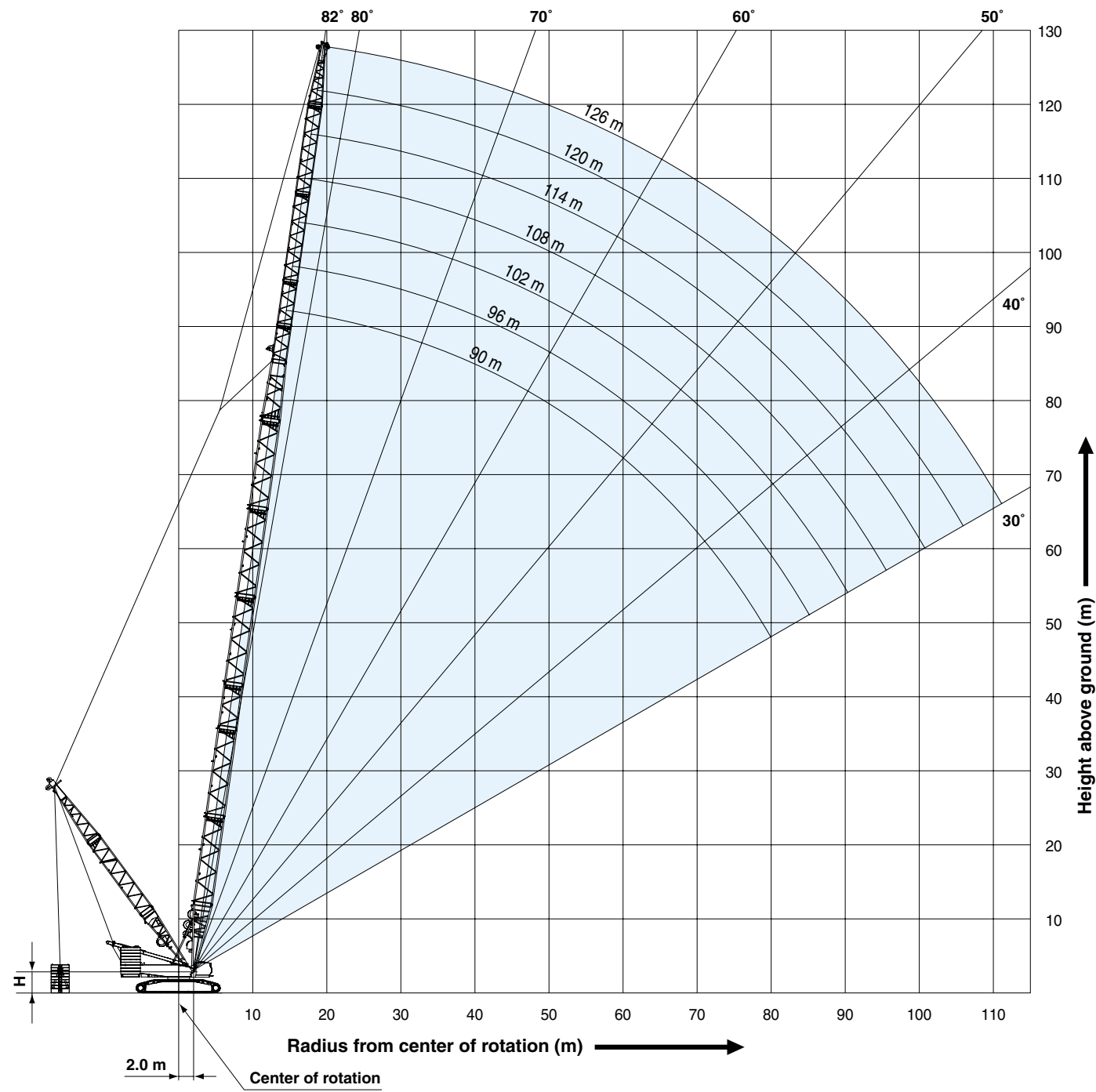

H=2.86 m Without quick connection ring
H=3.08 m With quick connection ring

Heavy Fixed Jib (Type B2)

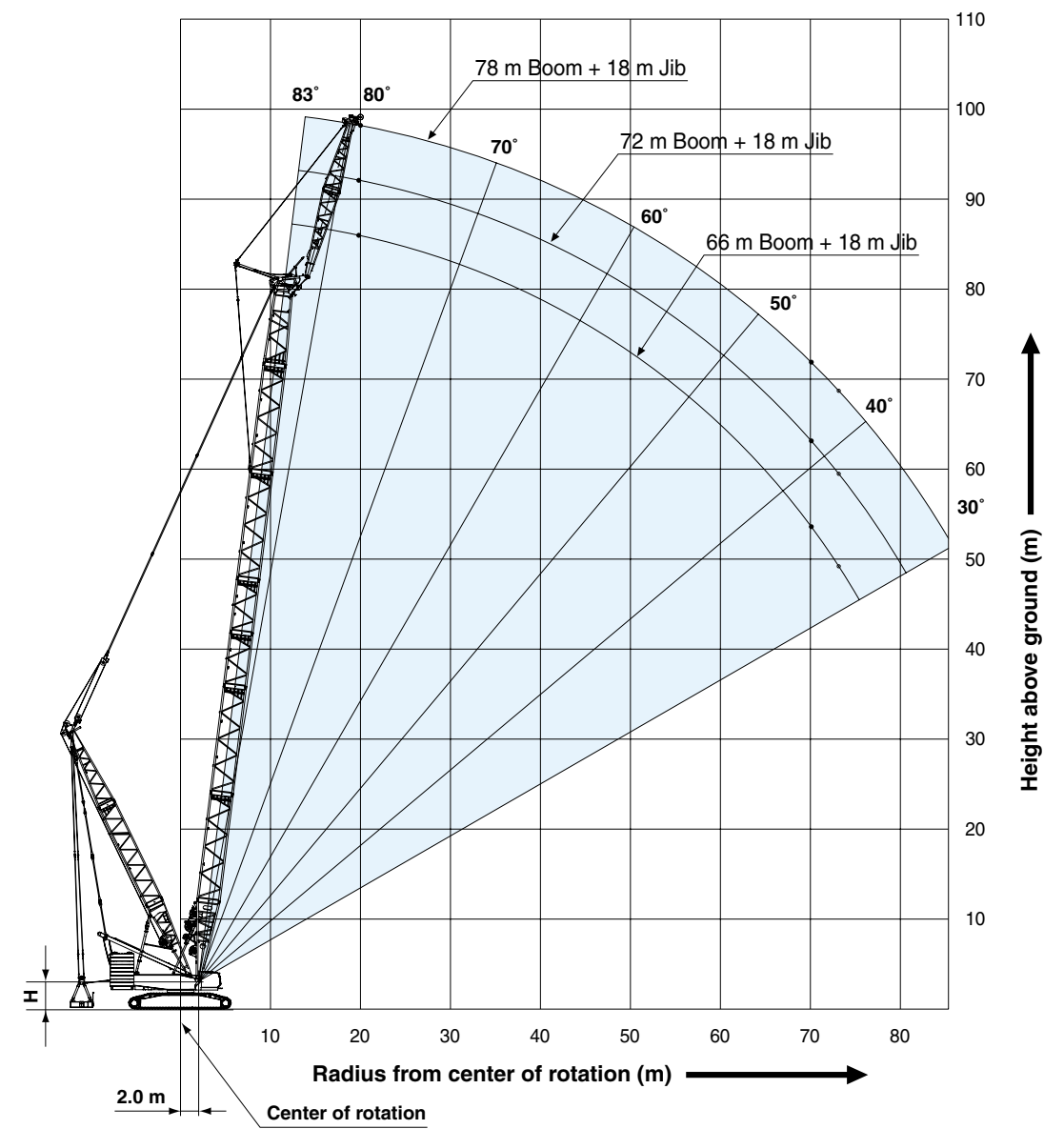

H=2.86 m Without quick connection ring
H=3.08 m With quick connection ring

WORKING RANGES

Heavy Fixed Jib (Type C)

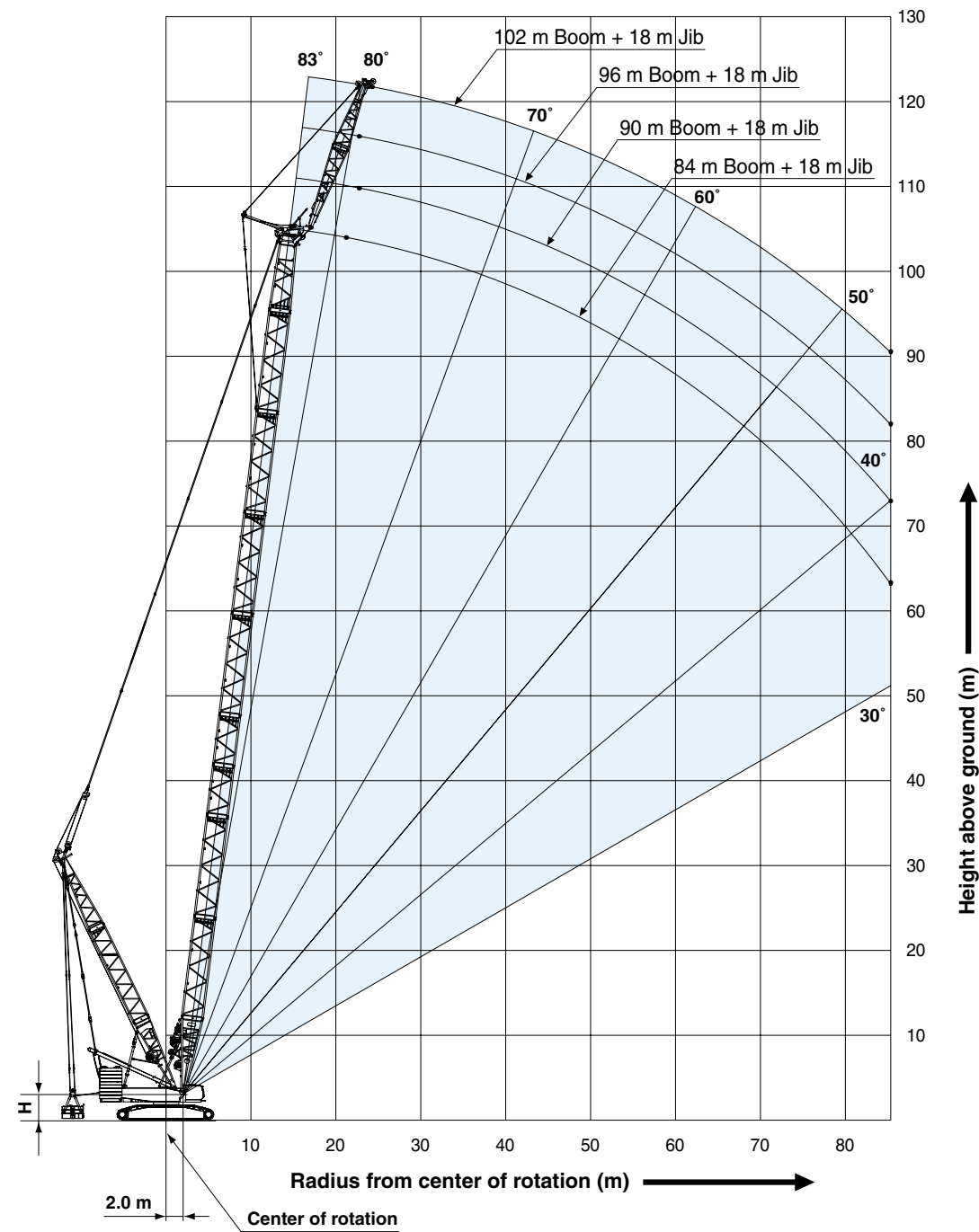

H=2.86 m Without quick connection ring
H=3.08 m With quick connection ring

Luffing Jib Boom Angle: 86°

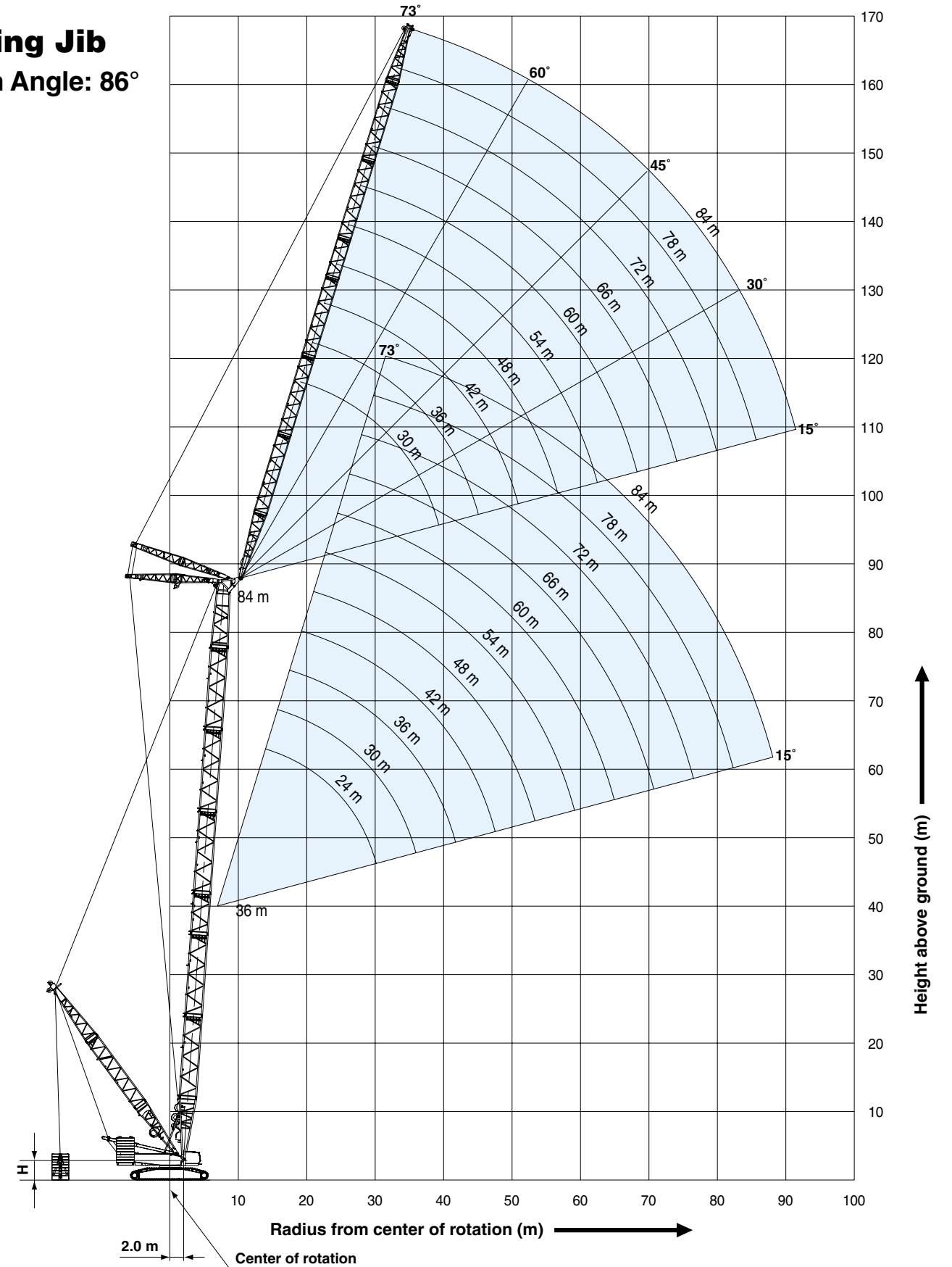

H=2.86 m Without quick connection ring
H=3.08 m With quick connection ring

WORKING RANGES

Luffing Jib
Boom Angle:
76°

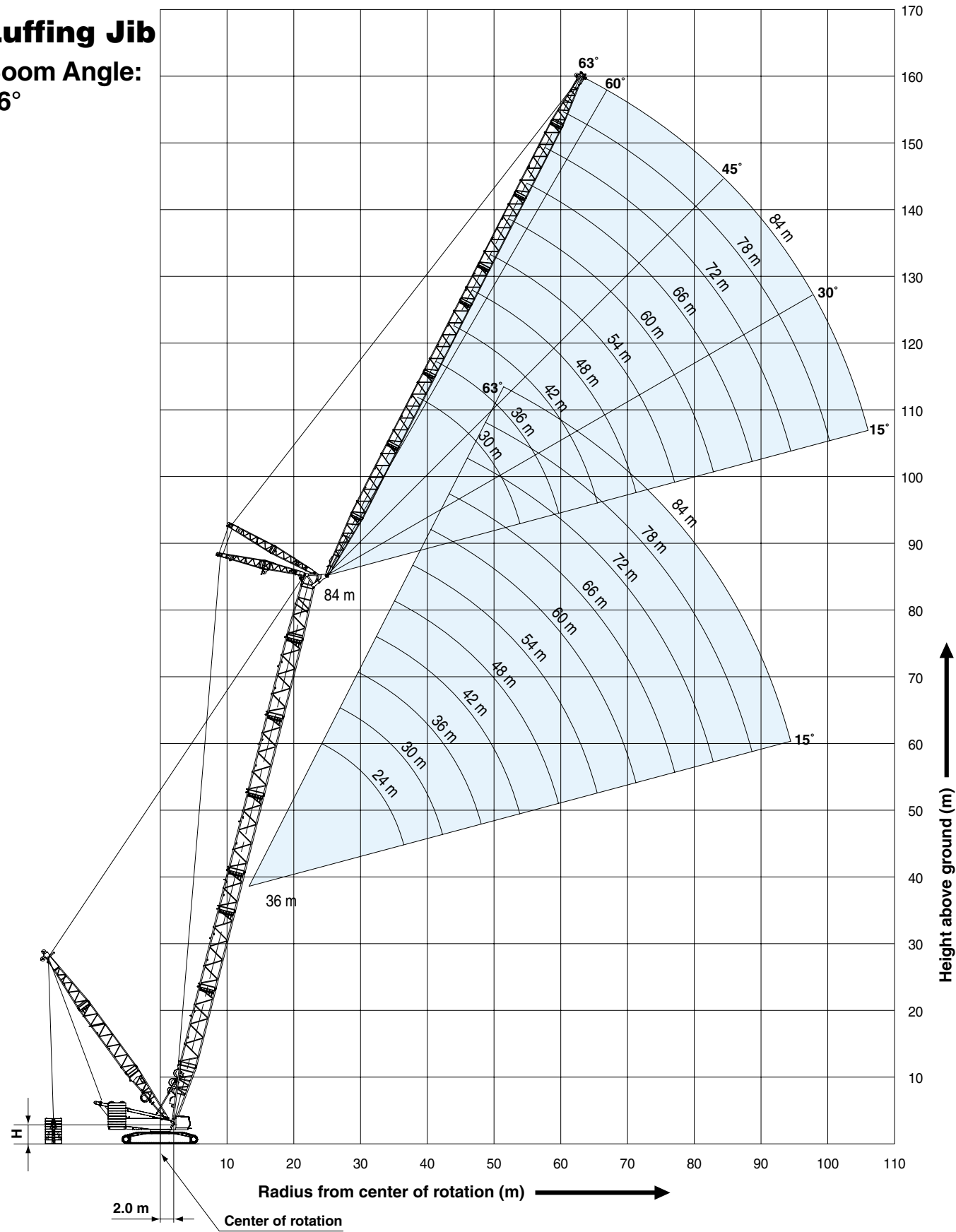

H=2.86 m Without quick connection ring
H=3.08 m With quick connection ring

Luffing Jib
Boom Angle:
66°

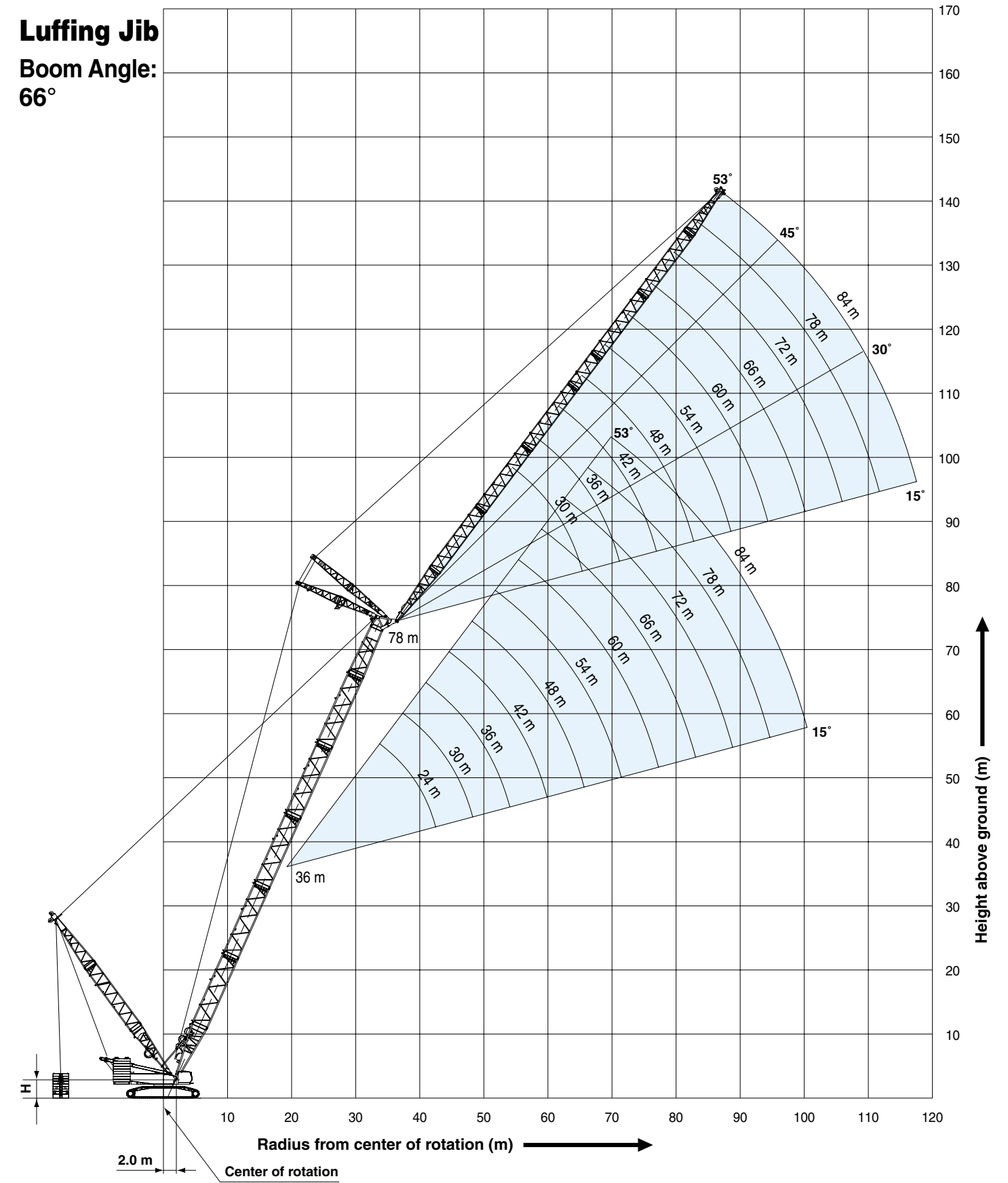

H=2.86 m Without quick connection ring
H=3.08 m With quick connection ring

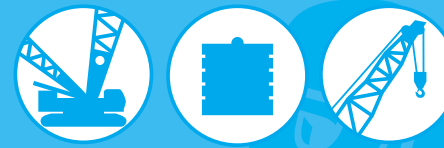
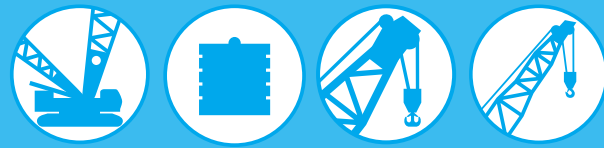

LIFTING CAPACITIES Heavy Duty Crane Boom Lifting Capacities

Unit: ton

Counterweight: 200.0 ton, Carbody weight: 50.0 ton
Pallet weight: 250.0 ton

Load Radius (m)	Boom Length (m)	36.0			42.0			48.0			54.0			60.0			Boom Length (m)	Load Radius (m)
		Palette weight			Palette weight			Palette weight			Palette weight			Palette weight				
		11 m	13 m	16 m	11 m	13 m	16 m	11 m	13 m	16 m	11 m	13 m	16 m	11 m	13 m	16 m		
8.0	8.3 m/550.0	8.3 m/550.0	8.3 m/550.0														8.0	
9.0	548.9	548.8	548.7	9.2 m/547.9	9.2 m/547.6	9.2 m/547.3											9.0	
10.0	528.0	547.0	547.0	526.8	547.6	547.3	10.0 m/450.0	10.0 m/450.0	10.0 m/450.0	10.9 m/370.0	10.9 m/370.0	10.9 m/370.0	11.7 m/336.0	11.7 m/336.0	11.7 m/336.0		10.0	
12.0	442.2	476.2	524.5	441.1	475.1	524.5	440.2	450.0	450.0	370.0	370.0	370.0	336.0	336.0	336.0		12.0	
14.0	379.8	409.2	449.6	378.7	408.1	449.6	377.9	407.3	449.6	370.0	370.0	370.0	336.0	336.0	336.0		14.0	
16.0	332.4	358.3	393.4	331.4	357.2	393.4	330.6	356.4	393.4	330.6	355.2	370.0	328.3	336.0	336.0		16.0	
18.0	295.2	318.3	349.7	294.2	317.3	349.7	293.4	316.5	349.7	292.2	315.3	349.6	291.2	314.3	336.0		18.0	
20.0	265.2	286.0	314.7	264.2	285.1	314.7	263.5	284.3	314.7	262.2	283.1	314.1	261.2	282.1	313.1		20.0	
22.0	240.5	259.5	286.1	239.5	258.5	286.1	238.8	257.8	286.1	237.6	256.6	284.9	236.6	255.6	283.9		22.0	
24.0	219.2	237.3	262.2	218.9	236.3	262.2	218.1	235.6	261.6	216.9	234.4	260.4	215.9	233.4	259.4		24.0	
26.0	199.4	218.4	236.2	199.4	217.4	241.5	199.3	216.7	240.7	199.0	215.5	239.6	198.4	214.5	238.6		26.0	
28.0	182.5	200.1	209.8	182.5	200.0	223.5	182.4	199.8	222.8	182.0	199.3	221.7	181.4	198.3	220.7		28.0	
30.0	168.1	181.5	186.1	168.1	184.3	206.8	167.9	184.1	206.5	167.5	183.6	205.9	166.8	182.9	205.1		30.0	
32.0	153.0	164.5	164.3	155.5	170.7	190.1	155.4	170.5	191.4	154.9	170.0	190.8	154.2	169.2	190.0		32.0	
34.0	33.8 m/139.9	33.8 m/150.4	33.8 m/145.2	144.6	158.8	171.6	144.4	158.6	178.2	143.9	158.1	177.6	143.2	157.3	176.7		34.0	
36.0				134.8	148.2	154.4	134.7	148.0	166.5	134.2	147.5	165.9	133.4	146.7	165.1		36.0	
38.0				126.2	136.3	138.2	126.0	138.7	156.1	125.6	138.1	155.6	124.8	137.3	154.7		38.0	
40.0				39.0 m/121.2	39.0 m/130.4	39.0 m/129.9	118.3	130.3	143.8	117.8	129.8	146.3	117.0	128.9	145.4		40.0	
44.0							105.0	115.3	118.1	104.5	115.4	130.3	103.8	114.5	129.4		44.0	
48.0							44.2 m/104.4	44.2 m/114.4	44.2 m/116.7	93.5	103.4	111.7	92.8	102.6	116.3		48.0	
52.0										49.4 m/90.1	49.4 m/99.7	49.4 m/104.5	83.5	92.6	104.7		52.0	
56.0													54.6 m/78.2	54.6 m/86.9	54.6 m/93.9		56.0	
Reeves	44	44	44	44	44	44	36	36	36	28	28	28	24	24	24	Reeves		

Load Radius (m)	Boom Length (m)	66.0			72.0			78.0			84.0			Boom Length (m)	Load Radius (m)
		Palette weight			Palette weight			Palette weight			Palette weight				
		11 m	13 m	16 m	11 m	13 m	16 m	11 m	13 m	16 m	11 m	13 m	16 m		
12.0	12.5 m/280.0	12.5 m/280.0	12.5 m/280.0	13.4 m/280.0	13.4 m/280.0	13.4 m/280.0									12.0
14.0	280.0	280.0	280.0	280.0	280.0	280.0	14.2 m/220.0	14.2 m/220.0	14.2 m/220.0	15.0 m/200.0	15.0 m/200.0	15.0 m/200.0			14.0
16.0	280.0	280.0	280.0	280.0	280.0	280.0	220.0	220.0	220.0	200.0	200.0	200.0			16.0
18.0	280.0	280.0	280.0	280.0	280.0	280.0	220.0	220.0	220.0	200.0	200.0	200.0			18.0
20.0	260.0	280.0	280.0	258.9	279.7	280.0	220.0	220.0	220.0	200.0	200.0	200.0			20.0
22.0	235.3	254.3	280.0	234.3	253.3	280.0	220.0	220.0	220.0	200.0	200.0	200.0			22.0
24.0	214.7	232.1	258.2	213.6	231.1	257.1	212.3	220.0	220.0	200.0	200.0	200.0			24.0
26.0	197.1	213.3	237.3	196.1	212.2	236.3	194.8	211.0	220.0	193.7	200.0	200.0			26.0
28.0	180.6	197.1	219.4	179.8	196.0	218.4	178.9	194.8	217.1	177.9	193.7	200.0			28.0
30.0	166.0	182.0	203.9	165.2	181.2	202.8	164.3	180.2	201.6	163.2	179.1	200.0			30.0
32.0	153.4	168.3	189.0	152.6	167.5	188.1	151.6	166.5	187.0	150.6	165.4	185.9			32.0
34.0	142.3	156.3	175.7	141.5	155.5	174.8	140.5	154.5	173.8	139.5	153.4	172.6			34.0
36.0	132.5	145.8	164.1	131.7	144.9	163.1	130.7	143.9	162.1	129.7	142.8	160.9			36.0
38.0	123.9	136.4	153.7	123.0	135.5	152.7	122.0	134.5	151.7	121.0	133.4	150.5			38.0
40.0	116.1	128.0	144.4	115.3	127.1	143.4	114.3	126.1	142.4	113.2	124.9	141.2			40.0
44.0	102.8	113.6	128.5	102.0	112.7	127.5	100.9	111.6	126.4	99.8	110.5	125.2			44.0
48.0	91.8	101.7	115.3	91.0	100.8	114.3	89.9	99.7	113.2	88.8	98.6	112.1			48.0
52.0	82.6	91.7	104.2	81.7	90.8	103.3	80.7	89.7	102.2	79.6	88.6	101.0			52.0
56.0	74.7	83.1	94.8	73.9	82.2	93.8	72.8	81.2	92.7	71.7	80.0	91.6			56.0
60.0	59.8 m/68.2	59.8 m/76.1	59.8 m/84.2	67.1	74.9	85.7	66.0	73.8	84.6	64.9	72.7	83.4			60.0
64.0				61.1	68.4	78.6	60.1	67.4	77.5	59.0	66.3	76.3			64.0
68.0				65.0 m/59.7	65.0 m/66.9	65.0 m/75.7	54.9	61.7	71.2	53.8	60.6	70.1			68.0
72.0							70.2 m/52.2	70.2 m/58.9	70.2 m/67.8	49.1	55.6	64.6			72.0
76.0										75.4 m/45.6	75.4 m/51.8	75.4 m/60.3			76.0
Reeves	20	20	20	20	20	20	16	16	16	16	16	16	Reeves		

Note: Designed and rated to comply with EN13000.

Ratings shown in are determined by the strength of the boom or other structural components.

Lifting capacities may vary depending on hook used or with / without auxiliary sheave.

Please refer rated chart in operator's cabin.

Please refer Page 21 for Crane Boom Supplemental Data.

Long Boom Lifting Capacities

Unit: ton

Counterweight: 200.0 ton, Carbody weight: 50.0 ton
Pallet weight: 250.0 ton x 11 m, 13 m, 16 m

Load Radius (m)	Boom Length (m)	90.0	96.0	102.0	108.0	114.0	120.0	126.0	Boom Length (m)	Load Radius (m)
		Palette weight								
		11 m	13 m	16 m	11 m	13 m	16 m	11 m		
14.0	15.0 m/98.0	15.8 m/98.0								14.0
16.0	98.0	98.0	16.7 m/84.0	17.5 m/84.0						16.0
18.0	98.0	98.0	84.0	84.0	18.3 m/80.0	19.2 m/70.0				18.0
20.0	98.0	98.0	84.0	84.0	79.4	70.0	20.0 m/60.0			20.0
22.0	98.0	98.0	84.0	84.0	78.7	70.0	59.3			22.0
24.0	98.0	98.0	84.0	84.0	78.0	69.3	58.5			24.0
26.0	98.0	97.7	84.0	83.9	77.3	68.7	57.8			26.0
28.0	98.0	93.1	84.0	80.1	76.6	68.0	57.0			28.0
30.0	98.0	89.0	84.0	76.6	75.9	67.3	53.8			30.0
32.0	96.3	84.2	84.0	73.2	75.2	66.0	51.1			32.0
34.0	92.7	79.8	84.0	69.9	72.2	63.0	48.4			34.0
36.0	89.2	74.9	81.1	66.4	69.3	60.2	45.7			36.0
38.0	86.0	69.8	77.3	62.9	66.5	57.8	43.4			38.0
40.0	83.4	65.0	74.8	60.1	63.7	55.1	41.9			40.0
44.0	75.9	55.7	68.2	54.8	58.8	50.3	39.4			44.0
48.0	69.2	48.1	63.0	51.3	53.4	47.2	37.0			48.0
52.0	64.2	43.8	58.4	47.6	50.3	44.5	34.7			52.0
56.0	59.6	40.7	54.2	44.6	47.7	42.3	32.7			56.0
60.0	55.4	38.1	50.1	41.8	45.1	40.2	31.0			60.0
64.0	52.4	36.0	47.1	38.9	42.7	38.4	29.6			64.0
68.0	50.2	34.5	45.0	36.5	40.9	36.9	28.4			68.0
72.0	48.1	33.3	42.8	34.6	39.2	35.6	27.4			72.0
76.0	46.3	32.2	41.0	33.0	37.6	34.3	26.5			76.0
80.0	44.2	31.4	38.9	31.2	36.1	33.3	25.8			80.0
84.0	80.1 m/44.2	30.8	37.9	30.3	35.1	32.4	25.1			84.0
88.0		85.3 m/30.6	36.9	29.3	34.3	31.7	24.6			88.0
92.0			90.5 m/36.2	28.5	33.6	31.1	23.9			92.0
96.0				95.7 m/28.0	32.9	30.5	23.5			96.0
100.0					30.9	30.1	22.9			100.0
104.0					100.9 m/30.4	28.2	22.3			104.0
108.0						106.1 m/27.2	22.0			108.0
112.0							111.3 m/21.8			112.0
Reeves	7	7	6	6	6	5	5	Reeves		

Note: Designed and rated to comply with EN13000.

Ratings shown in are determined by the strength of the boom or other structural components.

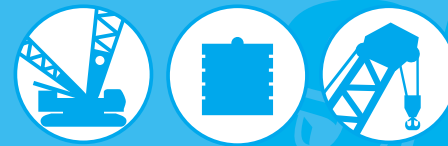

LIFTING CAPACITIES Heavy Fixed Jib (Type B2) Lifting Capacities

Heavy Lift Mast Point Radius: 11 m

Unit: ton

Counterweight: 200.0 ton
Carbody weight: 50.0 ton
Pallet weight: 10.0 ton x 11 m

Jib Length (m)		18.0			Jib Length (m)	
Working Radius (m)	Boom Length (m)	66.0	72.0	78.0	Boom Length (m)	Working Radius (m)
		20.0	120.0	120.0		
22.0	116.4	114.0	108.6	22.0		
24.0	103.1	102.2	97.7	24.0		
26.0	92.0	91.1	88.3	26.0		
28.0	82.7	81.7	80.1	28.0		
30.0	74.6	73.6	72.6	30.0		
34.0	61.6	60.6	59.4	34.0		
38.0	51.5	50.4	49.2	38.0		
42.0	43.5	42.3	41.1	42.0		
46.0	36.9	35.7	34.4	46.0		
50.0	31.4	30.2	28.9	50.0		
54.0	26.8	25.6	24.2	54.0		
58.0	22.8	21.6	20.3	58.0		
62.0	19.4	18.2	16.8	62.0		
66.0	16.5	15.2	13.8	66.0		
70.0	13.9	12.6	11.2	70.0		
74.0	11.6	10.3	8.9	74.0		
Reeves	10	10	10	Reeves		

Note:
Designed and rated to comply with EN13000.
Ratings shown in are determined by the strength of the boom or other structural components.
Lifting capacities may vary depending on hook used or with / without auxiliary sheave.
Please refer rated chart in operator's cabin.
Ratings enclosed in gray-color box in the table require double-drum specifications.
Please refer Page 21 for Heavy Fixed Jib Supplemental Data.

Heavy Fixed Jib (Type C) Lifting Capacities

Unit: ton

Counterweight: 200.0 ton
Carbody weight: 50.0 ton
Pallet weight: 130.0 ton x 11 m

Jib Length (m)		18.0				Jib Length (m)	
Working Radius (m)	Boom Length (m)	84.0	90.0	96.0	102.0	Boom Length (m)	Working Radius (m)
		22.0	105.0				
24.0	105.0	95.0	85.0		24.0		
26.0	105.0	95.0	85.0	80.0	26.0		
28.0	105.0	95.0	85.0	80.0	28.0		
30.0	105.0	95.0	85.0	80.0	30.0		
34.0	96.7	95.0	85.0	80.0	34.0		
38.0	82.2	81.2	80.0	78.8	38.0		
42.0	70.6	69.5	68.3	67.1	42.0		
46.0	61.2	60.0	58.8	57.6	46.0		
50.0	53.3	52.1	50.8	49.6	50.0		
54.0	46.6	45.4	44.1	42.9	54.0		
58.0	40.9	39.7	38.4	37.1	58.0		
62.0	36.0	34.8	33.4	32.1	62.0		
66.0	31.7	30.5	29.1	27.8	66.0		
70.0	27.9	26.7	25.3	24.0	70.0		
74.0	24.6	23.3	21.9	20.6	74.0		
78.0	21.6	20.3	18.9	17.6	78.0		
82.0	18.9	17.6	16.2	14.8	82.0		
86.0	84.0 m/17.7	84.0 m/16.4	84.0 m/15.0	84.0 m/13.6	86.0		
Reeves	8	8	8	8	Reeves		

Note:
Designed and rated to comply with EN13000.
Ratings shown in are determined by the strength of the boom or other structural components.
Ratings enclosed in gray-color box in the table require double-drum specifications.
Please refer Page 21 for Heavy Fixed Jib Supplemental Data.

Luffing Boom Lifting Capacities

Counterweight: 180.0 ton, Carbody weight: 50.0 ton
Pallet weight: 250.0 ton x 13 m

Unit: ton

Load Radius (m)	Boom Length (m)	36.0			42.0			48.0			54.0			60.0			Boom Length (m)	Load Radius (m)
		Palette weight			Palette weight			Palette weight			Palette weight			Palette weight				
		11 m	13 m	16 m	11 m	13 m	16 m	11 m	13 m	16 m	11 m	13 m	16 m	11 m	13 m	16 m		
8.0	8.5 m/300.0	8.5 m/300.0	8.5 m/300.0	9.3 m/300.0	9.3 m/300.0	9.3 m/300.0										8.0		
9.0	300.0	300.0	300.0	300.0	300.0	300.0										9.0		
10.0	300.0	300.0	300.0	300.0	300.0	300.0	10.2 m/300.0	10.2 m/300.0	10.2 m/300.0	11.0 m/280.0	11.0 m/280.0	11.0 m/280.0	11.8 m/280.0	11.8 m/280.0	11.8 m/280.0	10.0		
12.0	300.0	300.0	300.0	300.0	300.0	300.0	300.0	300.0	300.0	280.0	280.0	280.0	280.0	280.0	280.0	12.0		
14.0	300.0	300.0	300.0	300.0	300.0	300.0	300.0	300.0	300.0	280.0	280.0	280.0	280.0	280.0	280.0	14.0		
16.0	300.0	300.0	300.0	300.0	300.0	300.0	300.0	300.0	300.0	280.0	280.0	280.0	280.0	280.0	280.0	16.0		
18.0	283.9	300.0	300.0	282.9	300.0	300.0	281.9	300.0	300.0	280.0	280.0	280.0	279.7	280.0	280.0	18.0		
20.0	253.4	275.4	300.0	253.8	274.4	300.0	252.9	273.4	300.0	251.7	272.2	280.0	250.7	271.3	280.0	20.0		
22.0	226.0	248.1	277.5	226.3	248.3	276.6	226.3	247.7	275.6	225.8	246.5	274.4	225.6	245.6	273.5	22.0		
24.0	203.6	223.7	248.9	203.8	223.8	251.3	203.7	223.6	251.0	203.2	223.1	250.2	203.0	222.7	249.7	24.0		
26.0	185.0	202.5	223.0	185.1	203.4	228.6	184.9	203.2	228.3	184.4	202.6	227.5	184.1	202.2	227.1	26.0		
28.0	168.6	182.3	199.8	169.2	186.2	209.5	169.0	185.9	209.1	168.4	185.2	208.3	168.1	184.8	207.8	28.0		
30.0	152.2	164.7	177.0	155.6	171.4	193.0	155.4	171.1	192.6	154.8	170.4	191.9	154.4	170.0	191.3	30.0		
32.0	137.6	149.0	156.1	143.8	158.5	177.2	143.6	158.2	178.4	142.9	157.5	177.6	142.5	157.1	177.0	32.0		
34.0	33.9 m/124.8	33.9 m/135.1	33.9 m/136.8	133.5	147.1	161.9	133.2	147.0	165.9	132.6	146.3	165.1	132.1	145.8	164.5	34.0		
36.0				124.2	134.5	146.4	124.1	137.1	154.9	123.4	136.3	154.1	123.0	135.8	153.5	36.0		
38.0				113.6	123.0	130.7	116.0	128.2	145.1	115.3	127.5	144.3	114.8	127.0	143.7	38.0		
40.0				39.1 m/107.9	39.1 m/116.9	39.1 m/122.1	108.7	120.3	134.3	108.0	119.6	135.5	107.5	119.1	134.9	40.0		
44.0							95.5	103.6	111.0	95.5	106.0	120.4	95.0	105.5	119.9	44.0		
48.0							44.3 m/94.2	44.3 m/102.2	44.3 m/109.1	85.2	94.7	104.6	84.7	94.3	107.4	48.0		
52.0										49.5 m/81.7	49.5 m/89.7	49.5 m/97.3	76.0	84.8	96.9	52.0		
56.0													54.7 m/70.8	54.7 m/79.2	54.7 m/87.2	56.0		
Reeves	24	24	24	24	24	24	24	24	24	20	20	20	20	20	20	Reeves		

Load Radius (m)	Boom Length (m)	66.0			72.0			78.0			84.0			Boom Length (m)	Load Radius (m)
		Palette weight			Palette weight			Palette weight			Palette weight				
		11 m	13 m	16 m	11 m	13 m	16 m	11 m	13 m	16 m	11 m	13 m	16 m		
12.0	12.7 m/280.0	12.7 m/280.0	12.7 m/280.0	13.5 m/252.0	13.5 m/252.0	13.5 m/252.0							12.0		
14.0	280.0	280.0	280.0	252.0	252.0	252.0	14.3 m/213.5	14.3 m/213.5	14.3 m/213.5	15.2 m/182.8	15.2 m/182.8	15.2 m/182.8	14.0		
16.0	280.0	280.0	280.0	252.0	252.0	252.0	213.5	213.5	213.5	182.8	182.8	182.8	16.0		
18.0	278.4	280.0	280.0	252.0	252.0	252.0	213.5	213.5	213.5	182.8	182.8	182.8	18.0		
20.0	249.4	269.9	280.0	248.1	252.0	252.0	213.5	213.5	213.5	182.8	182.8	182.8	20.0		
22.0	224.9	244.3	272.2	224.1	243.0	252.0	213.5	213.5	213.5	182.8	182.8	182.8	22.0		
24.0	202.2	221.9	248.4	201.4	221.0	247.1	200.8	213.5	213.5	182.8	182.8	182.8	24.0		
26.0	183.3	201.3	226.1	182.4	200.4	225.1	181.7	199.7	213.5	180.8	182.8	182.8	26.0		
28.0	167.2	184.0	206.8	166.3	183.0	205.8	165.7	182.3	205.0	164.7	181.2	182.8	28.0		
30.0	153.5	169.1	190.3	152.6	168.1	189.3	151.9	167.3	188.5	150.9	166.3	182.5	30.0		
32.0	141.6	156.1	176.0	140.7	155.1	175.0	140.0	154.4	174.2	138.9	153.3	173.0	32.0		
34.0	131.2	144.9	163.5	130.2	143.8	162.5	129.5	143.1	161.6	128.5	142.0	160.5	34.0		
36.0	122.0	134.9	152.5	121.1	133.9	151.4	120.3	133.1	150.6	119.2	132.0	149.4	36.0		
38.0	113.9	126.0	142.7	112.9	125.0	141.6	112.1	124.2	140.8	111.0	123.1	139.6	38.0		
40.0	106.6	118.1	133.9	105.6	117.1	132.8	104.8	116.3	132.0	103.7	115.1	130.8	40.0		
44.0	94.1	104.5	118.8	93.1	103.5	117.7	92.3	102.7	116.9	91.2	101.5	115.7	44.0		
48.0	83.8	93.3	106.4	82.7	92.2	105.3	81.9	91.4	104.4	80.8	90.3	103.3	48.0		
52.0	75.1	83.9	95.9	74.0	82.8	94.8	73.2	82.0	94.0	72.1	80.8	92.8	52.0		
56.0	67.6	75.8	87.0	66.6	74.7	85.9	65.8	73.9	85.1	64.7	72.8	83.9	56.0		
60.0	59.9 m/61.4	59.9 m/69.0	59.9 m/77.8	60.2	67.8	78.2	59.4	67.0	77.4	58.3	65.8	76.2	60.0		
64.0				54.6	61.7	71.5	53.8	60.9	70.7	52.7	59.8	69.5	64.0		
68.0				65.1 m/53.2	65.1 m/60.2	65.1 m/69.4	48.9	55.6	64.7	47.8	54.4	63.6	68.0		
72.0							70.3 m/46.4	70.3 m/52.8	70.3 m/61.7	43.4	49.7	58.3	72.0		
76.0										75.5 m/40.0	75.5 m/46.0	75.5 m/54.2	76.0		
Reeves	20	20	20	20	20	20	16	16	16	16	16	16	Reeves		

Note: Designed and rated to comply with EN13000.
Ratings shown in are determined by the strength of the boom or other structural components.
This is rated for double drum.
Lifting capacities may vary depending on hook used or with

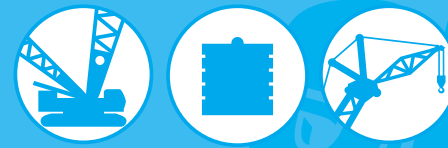

LIFTING CAPACITIES

Luffing Jib Lifting Capacity

Unit: ton

Counterweight: 200.0 ton, Carbody weight: 50.0 ton
Pallet weight: 130.0 ton x 16 m

36.0 m Boom Length	Boom length (m)		36.0															Boom length (m)				
	Jib length (m)		24.0			30.0			36.0			42.0			48.0			54.0			Jib length (m)	
	Boom angle		86°	76°	66°	86°	76°	66°	86°	76°	66°	86°	76°	66°	86°	76°	66°	86°	76°	66°	Boom angle	
14.4	200.0																				14.4	
15.0	193.2																				15.0	
16.0	182.2																				16.0	
17.0	176.9				171.2																17.0	
18.0	172.3				165.7			162.1													18.0	
20.0	164.7				156.4			152.0			143.5										20.0	
22.0	159.2				148.8			143.5			139.3			137.6							22.0	
24.0	155.9				142.8			136.3			132.4			129.6			119.3				24.0	
26.0	145.9	156.4			138.0			130.4			125.8			122.7			118.2				26.0	
28.0	129.4	149.8			134.7	142.2			125.4			120.2			116.7		114.3				28.0	
30.0	98.3	144.9			121.0	135.4			121.4			115.4			111.5		108.8				30.0	
34.0		130.7			99.8	125.6			103.2	118.9			105.8	115.0		103.0		99.8			34.0	
38.0			114.7			116.9	113.7			87.6	110.5			89.9	105.4		91.9	102.2			38.0	
42.0			101.7			98.0	100.8			104.7	100.6	78.0	98.3		79.7	94.2		81.3	91.6		42.0	
46.0						90.4				91.8	90.2	64.8	93.1	89.3	70.3	88.1		71.7	84.9		46.0	
50.0										81.7		81.3	80.8	62.6	82.4	79.9	63.9	79.6			50.0	
54.0										74.6			73.6		72.2	72.7	57.6	72.5	71.7		54.0	
58.0													67.6		63.5	66.7	48.0	64.7	65.7		58.0	
62.0															61.5			58.5	60.5		62.0	
66.0																			56.1	66.0		
70.0																				52.2	70.0	
Reeves			16			16			12			12			12			12			Reeves	

Luffing Jib Lifting Capacity

Unit: ton

Counterweight: 200.0 ton, Carbody weight: 50.0 ton
Pallet weight: 130.0 ton x 16 m

42.0 m Boom Length	Boom length (m)		42.0															Boom length (m)				
	Jib length (m)		24.0			30.0			36.0			42.0			48.0			54.0			Jib length (m)	
	Boom angle		86°	76°	66°	86°	76°	66°	86°	76°	66°	86°	76°	66°	86°	76°	66°	86°	76°	66°	Boom angle	
15.4	191.5																				15.4	
16.0	188.0																				16.0	
17.0	182.7							176.8													17.0	
18.0	178.1							171.3													18.0	
20.0	170.7							162.0						157.3							20.0	
22.0	165.5							154.5						148.7			145.1			133.1	22.0	
24.0	162.6							148.5						141.6			137.4			131.3	24.0	
26.0	149.7							144.0						135.7			130.8			127.5	26.0	
28.0	132.6	158.0						137.9						130.8			125.2			121.4	28.0	
30.0	112.9	148.1						123.6	143.5					127.0			120.4			116.2	30.0	
34.0		130.7						101.8	130.7					105.1	126.0		107.9			107.7	34.0	
38.0		116.9	112.4					116.7	116.7					89.0	116.7		91.5	111.7		93.5	38.0	
42.0			99.6					103.5	98.6					73.0	103.4		79.2	102.6		81.0	42.0	
46.0									88.4					92.8	88.3	69.4	91.9			71.1	46.0	
50.0									80.1						79.9		83.2	78.9	63.3	82.3	50.0	
54.0															72.8		73.9	71.9		75.0	54.0	
58.0																	65.9		66.2	65.0	58.0	
62.0																	60.9		60.0		62.0	
66.0																		55.6		52.6	66.0	
70.0																				50.7	70.0	
74.0																				47.4	74.0	
Reeves			16			16			12			12			12			12		8	Reeves	

36.0 m Boom Length	Boom length (m)		36.0															Boom length (m)			
	Jib length (m)		60.0			66.0			72.0			78.0			84.0			Jib length (m)			
	Boom angle		86°	76°	66°	86°	76°	66°	86°	76°	66°	86°	76°	66°	86°	76°	66°	Boom angle			
26.0	100.9																				26.0
28.0	100.1				89.1																28.0
30.0	94.9				88.5				73.4												30.0
34.0	85.9				87.1				72.3					62.4			54.1				34.0
38.0	78.3				84.6				70.3					60.1			50.5				38.0
42.0	71.9	83.2			79.0				65.3					55.5			46.4				42.0
46.0	66.3	76.2			69.0	80.6			60.9					51.5			42.8				46.0
50.0	61.6	70.6			60.7	74.6			57.0	63.9				48.0	54.2		39.7				50.0
54.0	57.4	65.4			53.9	67.7			53.4	59.8				44.9	50.5		37.0	41.8			54.0
58.0	53.2	62.9	65.7		48.0	59.8			47.6	57.5				42.2	47.2		34.5	38.8			58.0
62.0	48.0	58.8	60.5	43.0	53.2	59.4	43.0	53.3		39.7	44.2			32.3	36.2						62.0
66.0		52.8	56.0	38.5	47.6	54.9	38.6	47.7	54.1	37.4	41.6			30.3	33.8						66.0
70.0		47.0	52.0	34.5	42.7	50.4	34.7	42.9	49.8	35.1	39.2	43.3		28.5	31.7						70.0
74.0			48.5		38.3	45.3	31.1	38.6	44.8	31.6	37.0	40.9		26.8	29.8		33.1				74.0
78.0					40.9			34.8	40.5	28.5	34.9	38.7		25.3	28.1		31.1				78.0
82.0						37.5			31.3	25.0	31.5	36.0		23.7	26.5		29.3				82.0
86.0									34.3		28.5	33.7		22.3	25.1		27.7				86.0
90.0												30.8		23.8	26.3		25.0				90.0
94.0													27.8	22.6	25.0		24.4				94.0
98.0															23.9		23.3				98.0
Reeves			8			8			8			8			8			8			Reeves

42.0 m Boom Length	Boom length (m)		42.0															Boom length (m)			
	Jib length (m)		60.0			66.0			72.0			78.0			84.0			Jib length (m)			
	Boom angle		86°	76°	66°	86°	76°	66°	86°	76°	66°	86°	76°	66°	86°	76°	66°	Boom angle			
26.0	95.1																				26.0
28.0	94.2							82.4													28.0
30.0	93.1							81.7						69.6							30.0
34.0	86.6							80.0						68.4			59.3			51.5	34.0
38.0	78.9							77.9						66.9			58.2			50.7	38.0
42.0	72.3							75.4						65.1			55.8			46.6	42.0
46.0	66.7	78.4						69.8	84.6					61.1			51.8			43.0	46.0
50.0	61.9	72.5						61.3	79.1					57.2	65.3		48.2			39.8	50.0
54.0	57.6	68.3						54.3	69.4					53.7	62.4		45.0	51.6		37.2	54.0
58.0	53.8	62.7						48.4	61.3					48.0	58.6		42.2	48.2		34.7	58.0
62.0	48.4	58.0	59.0	43.3	54.9	57.8	43.0	55.2		39.7	45.1			32.5	37.1		32.5	37.1			62.0
66.0		54.4	54.5	38.8	49.0	53.4	38.6	49.5	52.6	37.4	42.3			30.4	34.7						66.0
70.0		49.4	50.6	34.8	43.9	49.5	34.7	44.4	48.7	34.2	39.9	44.8									

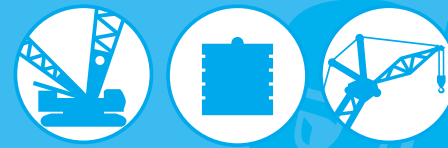

LIFTING CAPACITIES Luffing Jib Lifting Capacity

Unit: ton

Counterweight: 200.0 ton, Carbody weight: 50.0 ton
Pallet weight: 130.0 ton x 16 m

60.0 m Boom Length	Boom length (m)		60.0																		Boom length (m)		
	Jib length (m)		24.0			30.0			36.0			42.0			48.0			54.0			Jib length (m)		
	Boom angle		86°	76°	66°	86°	76°	66°	86°	76°	66°	86°	76°	66°	86°	76°	66°	86°	76°	66°	Boom angle		
Working Radius (m)	17.8		190.1																			17.8	
	18.0		189.1			164.0																	18.0
	20.0		181.2			164.0			144.3														20.0
	22.0		175.6			159.6			140.2			121.8											22.0
	24.0		163.8			152.9			135.6			118.9			103.9								24.0
	26.0		150.9			146.0			130.8			115.5			101.8			89.3					26.0
	28.0		139.6			139.2			125.7			111.9			99.3			87.7					28.0
	30.0		126.9			130.1			120.5			108.2			96.7			85.9					30.0
	34.0			129.1		107.8	128.1		110.6			100.5			91.0			81.8					34.0
	38.0			112.8			111.8		93.6	111.9		92.9			85.0			77.3					38.0
	42.0				99.9		99.0		80.2	99.1		82.7	98.1		79.2			72.7					42.0
	46.0					82.9		88.7			88.8		72.3	87.8		73.7	86.9		68.1	85.9			46.0
	50.0						74.9			73.8		80.3			79.4	65.6	78.5		63.8	77.5			50.0
	54.0								67.2			67.2			72.3	58.6	71.4		59.7	70.4			54.0
	58.0								61.7			61.6	60.5		65.4		64.4		53.5	64.4			58.0
	62.0									56.7			55.7		60.3	54.8		59.2	53.7				62.0
	66.0												51.6			50.6	54.8	49.5					66.0
	70.0															47.0	51.0	45.9					70.0
74.0																43.9		42.8				74.0	
78.0																		40.0				78.0	
Reeves				16			16			12			12			8			8			Reeves	

Luffing Jib Lifting Capacity

Unit: ton

Counterweight: 200.0 ton, Carbody weight: 50.0 ton
Pallet weight: 130.0 ton x 16 m

66.0 m Boom Length	Boom length (m)		66.0																		Boom length (m)		
	Jib length (m)		24.0			30.0			36.0			42.0			48.0			54.0			Jib length (m)		
	Boom angle		86°	76°	66°	86°	76°	66°	86°	76°	66°	86°	76°	66°	86°	76°	66°	86°	76°	66°	Boom angle		
Working Radius (m)	18.5		164.0																				18.5
	20.0		164.0									148.3											20.0
	22.0		161.6									142.6									111.8		22.0
	24.0		153.4									136.5									109.0		24.0
	26.0		141.6									130.5									105.8		26.0
	28.0		131.3									124.4									91.4		28.0
	30.0		122.1									118.6									99.0		30.0
	34.0											107.0									91.8		34.0
	38.0											91.6	110.0		95.3	110.1					84.8		38.0
	42.0											87.1			87.3	72.7	86.3	96.5	72.4				42.0
	46.0																						46.0
	50.0																						50.0
	54.0																						54.0
	58.0																						58.0
	62.0																						62.0
	66.0																						66.0
	70.0																						70.0
	74.0																						74.0
78.0																						78.0	
82.0																						82.0	
Reeves																						Reeves	

60.0 m Boom Length	Boom length (m)		60.0																		Boom length (m)		
	Jib length (m)		60.0			66.0			72.0			78.0			84.0			Jib length (m)					
	Boom angle		86°	76°	66°	86°	76°	66°	86°	76°	66°	86°	76°	66°	86°	76°	66°	Boom angle					
Working Radius (m)	28.0		76.9																			28.0	
	30.0		75.6			66.6																	30.0
	34.0		72.8			64.5			56.2			49.8			43.6								34.0
	38.0		69.5			62.2			54.5			48.6			42.7								38.0
	42.0		66.0			59.6			52.6			47.1			41.6								42.0
	46.0		62.4			56.8			50.4			45.5			40.4								46.0
	50.0		58.8	77.8		53.9	70.3		48.2			43.8			39.1								50.0
	54.0		55.4	70.7		51.0	69.6		46.0	59.9		42.0			37.4								54.0
	58.0		52.1	64.7		48.3	63.6		43.7	59.6		40.1	51.5		34.7	42.7							58.0
	62.0		49.2	59.5		44.3	58.4		41.5	57.1		38.3	48.0		32.4	39.8							62.0
	66.0		44.2	55.0	49.8	39.6	53.9		39.4	53.1		36.6	44.9		30.2	37.1							66.0
	70.0			51.1	46.1	35.4	48.5	44.9	35.4	48.0		34.8	42.2		28.3	34.7							70.0
	74.0				47.6	42.9		43.4	41.7	31.8	43.0	40.8	31.3		26.5	32.5							74.0
	78.0					40.0		39.2	38.8	28.5	38.6	38.0	28.2	37.4	36.8	25.0	30.5						78.0
	82.0						37.5		35.2	36.3		35.9	35.5	25.4	34.9	34.5	23.6	28.7	32.9				82.0
	86.0							35.3		34.0		32.4	33.2		32.6	32.1	22.3	27.1	31.4				86.0
	90.0									32.0			31.1		29.5	30.2		25.6	29.3				90.0
	94.0												29.3		26.3	28.3		24.2	27.5				94.0
98.0													27.7		26.7		22.5	25.8				98.0	
102.0															25.2		24.3	102.0				102.0	
106.0																	22.9	106.0				106.0	
110.0																	21.6	110.0				110.0	
Reeves																		Reeves				Reeves	

66.0 m Boom Length	Boom length (m)		66.0																		Boom length (m)		
	Jib length (m)		60.0			66.0			72.0			78.0			84.0			Jib length (m)					
	Boom angle		86°	76°	66°	86°	76°	66°	86°	76°	66°	86°	76°	66°	86°	76°	66°	Boom angle					
Working Radius (m)	28.0		71.3																			28.0	
	30.0		70.1									61.8											30.0
	34.0		67.3									59.8			52.6						46.3		34.0
	38.0		64.1									57.5			50.9						45.1		38.0
	42.0		60.7									54.9			48.9						43.7		42.0
	46.0		57.3									52.2			46.8						42.1		46.0
	50.0		53.9	75.7								49.5			44.7						40.4		50.0
	54.0		50.6	69.4								46.7	65.4		42.5	56.3					38.6		54.0
	58.0		47.6	63.5								44.1	62.3		40.3	56.1					36.8	48.7	58.0
	62.0		44.9	58.3								41.7	57.2		38.2	55.4					35.1	48.5	62.0
	66.0		42.6	53.9								39.4	52.8		36.2	52.0					33.4	45.8	66.0
	70.0			50.0	44.4							35.7	48.9		34.4	48.1					31.7	42.9	70.0
	74.0																						

Base Machine

Base machine (A)

With

- Upper/Lower connecting device
- Crane mast
- Mast raising cylinder
- Carbody
- Lower translifter

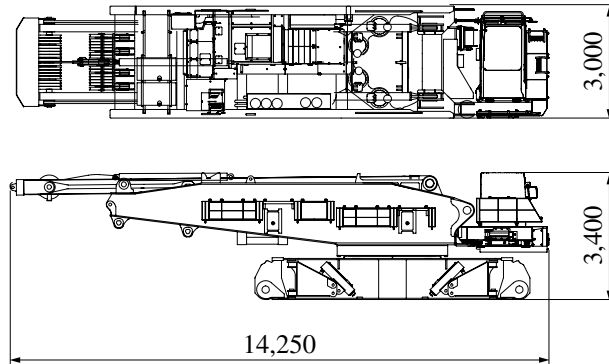

Weight 63,530 kg
Width 3.0 m
Height 3.4 m
(Machine)
Length 14.25 m

Without

- Upper translifter
- Aux. platform
- Boom foot pin removal cylinder
- Reeving winch

Upper Structure

Upper Structure (A)

With

- Upper/Lower connecting device (Upper)
- Crane mast
- Mast raising cylinder

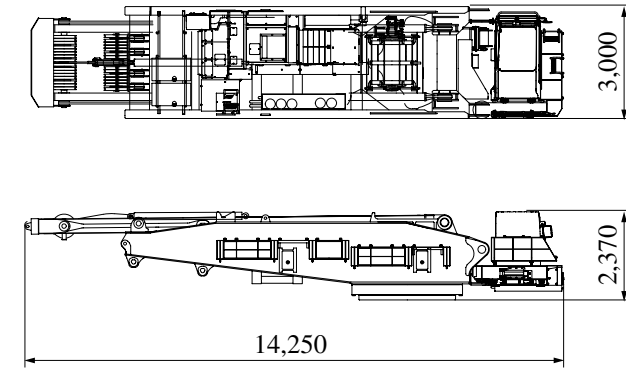

Weight 44,310 kg
Width 3.0 m
Height 2.37 m
(Machine)
Length 14.25 m

Without

- Upper translifter
- Lower translifter
- Aux. platform
- Boom foot pin removal cylinder
- Reeving winch
- Carbody

Base machine (B)

With

- Upper/Lower connecting device
- Carbody
- Lower translifter

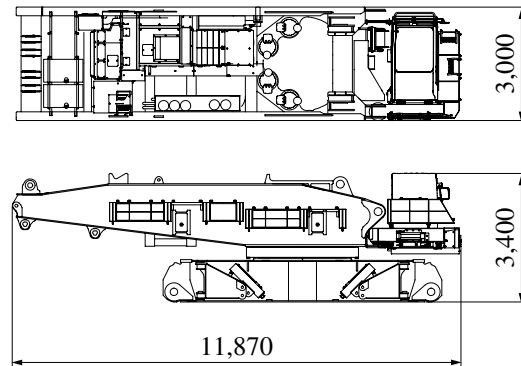

Weight 51,220 kg
Width 3.0 m
Height 3.4 m
(Machine)
Length 11.87 m

Without

- Crane mast
- Mast raising cylinder
- Upper translifter
- Aux. platform
- Boom foot pin removal cylinder
- Reeving winch

Upper Structure (B)

With

- Upper/Lower connecting device (Upper)
- Crane mast
- Mast raising cylinder
- Upper translifter

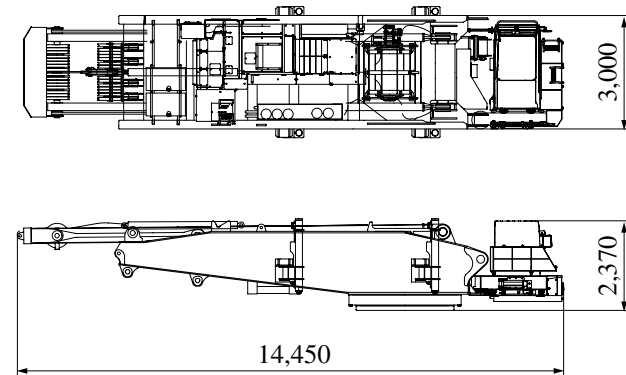

Weight 46,730 kg
Width 3.0 m
Height 2.37 m
(Machine)
Length 14.45 m

Without

- Aux. platform
- Boom foot pin removal cylinder
- Reeving winch
- Carbody
- Lower translifter

Base machine (C)

With

- Carbody

Without

- Upper/Lower connecting device
- Crane mast
- Mast raising cylinder
- Upper translifter
- Lower translifter
- Aux. platform
- Boom foot pin removal cylinder
- Reeving winch

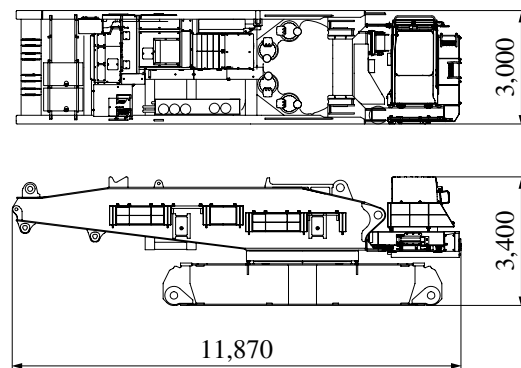

Weight 48,810 kg
Width 3.0 m
Height 3.4 m
(Machine)
Length 11.87 m

Upper Structure (C)

With

- Upper/Lower connecting device (Upper)

Without

- Crane mast
- Mast raising cylinder
- Upper translifter
- Aux. platform
- Boom foot pin removal cylinder
- Reeving winch
- Carbody
- Lower translifter

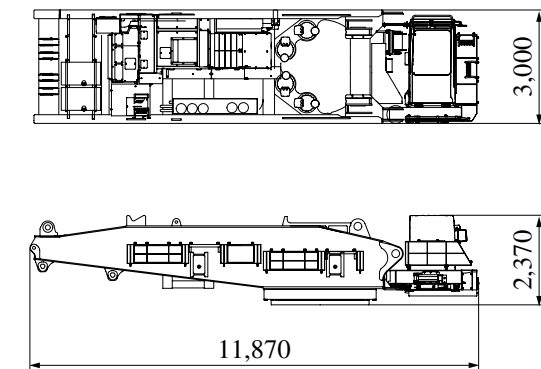

Weight 32,000 kg
Width 3.0 m
Height 2.37 m
(Machine)
Length 11.87 m

Base Machine (A)

With upper/lower connecting devices, crane mast, mast raising cylinder, Carbody, lower transflifer.
Weight: 63,530 kg Width: 3,000 mm

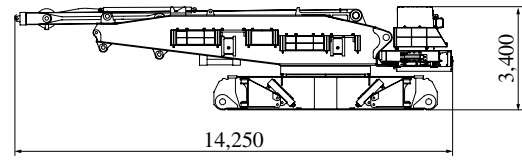

Carbody

With upper/lower connecting devices.
Weight: 22,610 kg Width: 2,990 mm

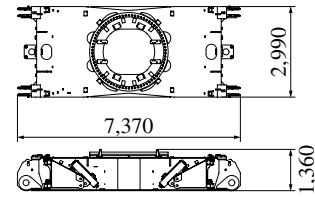

Crawler frame

Weight: 40,000 kg Width: 1,500 mm

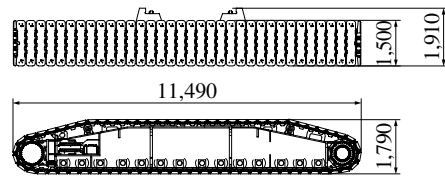

Crane Mast

Weight: 12,310 kg

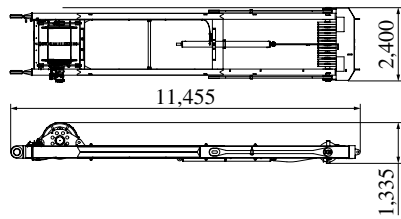

Base Counterweight

Weight: 20,000 kg

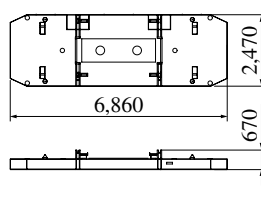

Base Carbody Weight (5 t)

(with link)
Weight: 5,400 kg

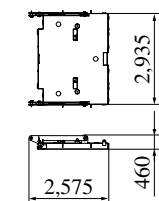

Counterweight (L/R)

Carbody Weight (F/R)
Weight: 10,000 kg

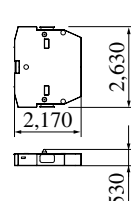

Base Pallet Weight (10t) (with link)

Weight: 9,300 kg

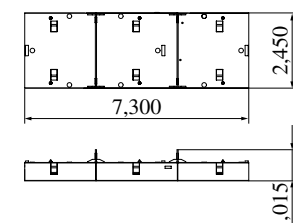

Pallet Weight

Weight: 10,000 kg

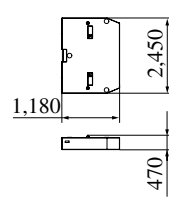

Dimensions: mm Weight: kg

9 m Boom Base

With H1, H2 and W2 winches including ropes, guide sheave, and boom backstop
Weight: 28,440 kg

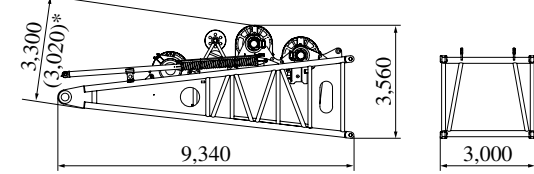

* When the H1 drum winch is stowed.

6 m Boom Insert

With 6 m guy line (link) x 4
Weight: 3,740 kg

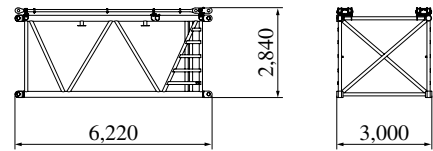

12 m Boom Insert

With 12 m guy line (link) x 4
Weight: 6,740 kg

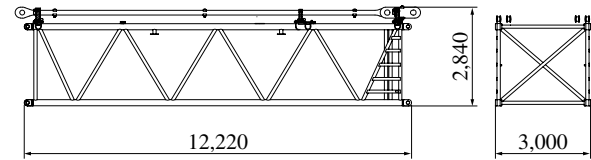

8 m Tapered Boom

With 8 m guy line (link) x 2
Weight: 5,210 kg

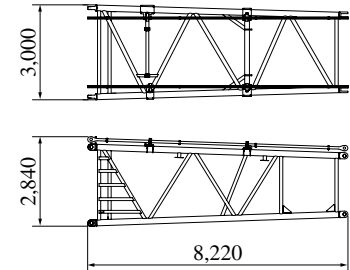

Heavy Boom Tip

Weight: 4,910 kg

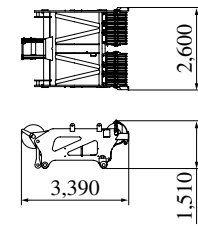

Luffing Boom Tip

Weight: 5,520 kg

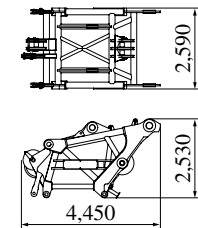

10 m Mast Base

Weight: 13,700 kg

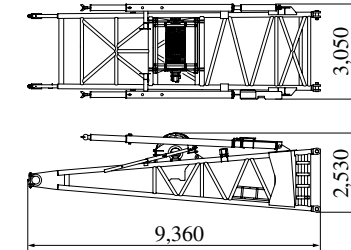

12 m Mast Insert

With guy line
Weight: 5,650 kg

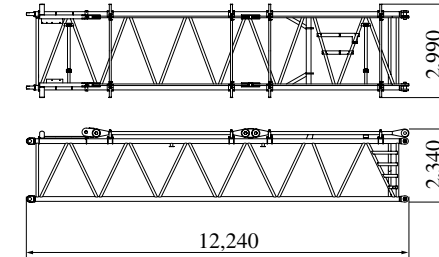

9 m Mast top

With guy line
Weight: 10,080 kg

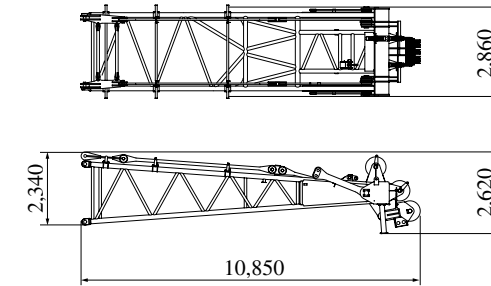

Hanger sheave

Weight: 2,010 kg

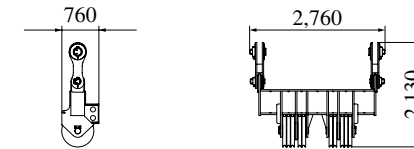

550 t Hook

Weight: 11,730 kg

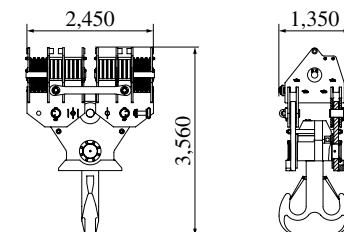

Dimensions: mm Weight: kg

300 t Hook

Weight: 7,870 kg

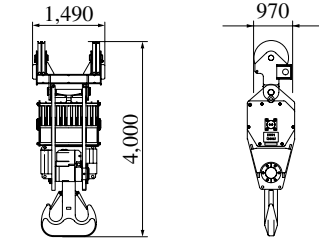

200 t Hook

Weight: 7,100 kg

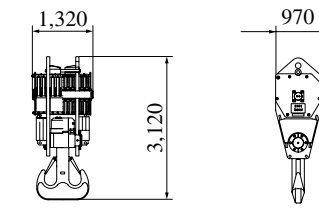

120 t Hook

Weight: 4,500 kg

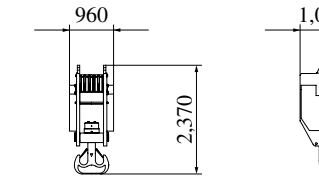

70 t Hook

Weight: 3,100 kg

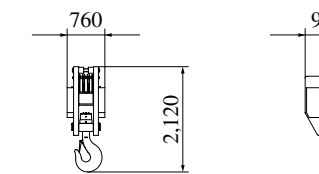

40 t Hook

Weight: 2,000 kg

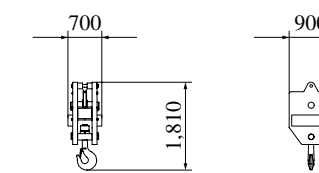

Ball hook

Weight: 830 kg

